

# Cartilage MICROTOME

## Accurate

Accurate and consistent measurements  
Broad thickness range [0.1mm up to 0.9mm]

## Simple

Simple to assemble and operate  
Eliminates need for distance plates



## Safe

Safeguard for hands and fingers  
Stability to safely guide cutting motion

- 990-001 Cartilage Microtome
- 990-002 Cartilage Microtome Blades (6/box)

8500 Wolf Lake Drive, Suite 110 • Memphis, TN 38133 • USA Toll Free 1.866.472.2363 • [www.gracemedical.com](http://www.gracemedical.com)

LIT0129 CID3387

- A. Blade
- B. Cartilage Knife
- C. Measuring Dial
- D. Base
- E. Cartilage Support

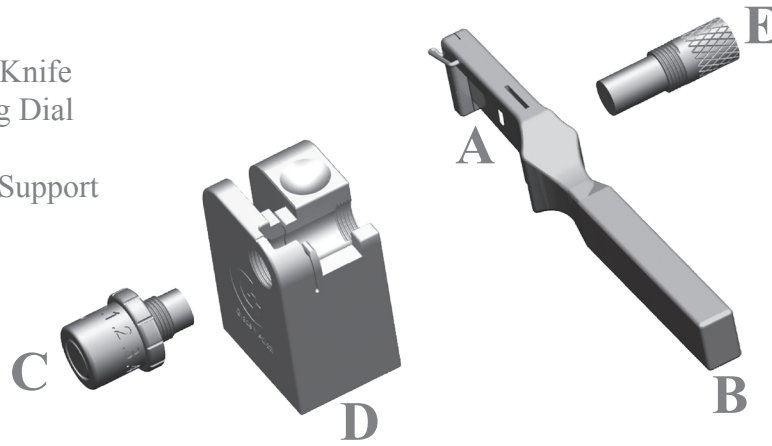

1. Insert blade (A) into cartilage knife (B) and rotate lock to secure.

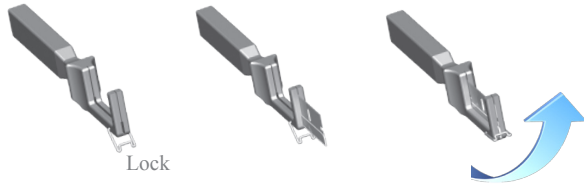

2. Insert measuring dial (C) into base (D) and rotate clockwise until measuring dial (C) stops at 0.1mm.

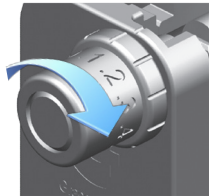

3. Rotate measuring dial (C) counter-clockwise to desired thickness.



4. Insert cartilage specimen into holding cavity of base (D).

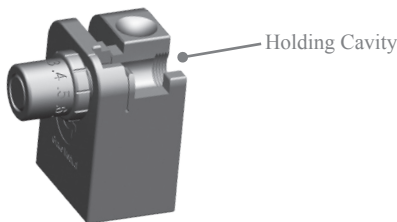

5. Insert cartilage support (E) into base (D) and rotate clockwise to secure cartilage specimen. **IMPORTANT!** To avoid crushing cartilage specimen, stop rotating when cartilage specimen rests snugly between measuring dial (C) and cartilage support (E).



6. Tilt blade-end of cartilage knife (B) downward slightly and insert into guide slot of base (D).

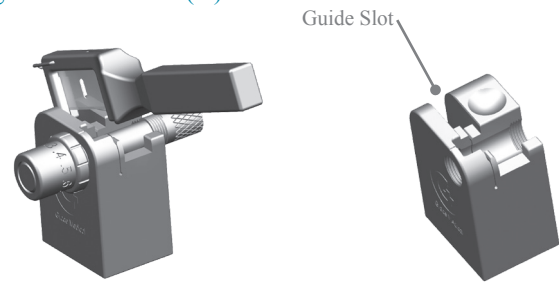

7. Press downward on handle-end of cartilage knife (B) to cut cartilage specimen into desired thickness. **IMPORTANT!** To avoid difficulty in removal of blade (A) from cartilage knife (B), do not use excessive force when pressing downward.

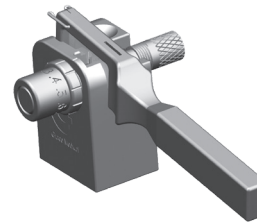

8. Rotate measuring dial (C) and cartilage support (E) counter-clockwise to reduce pressure on cartilage specimen before removing cartilage knife (B) from base (D).

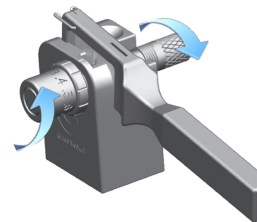

9. Remove measuring dial (C) and cartilage support (E) completely from base (D) and extract cartilage specimen with desired thickness.

