

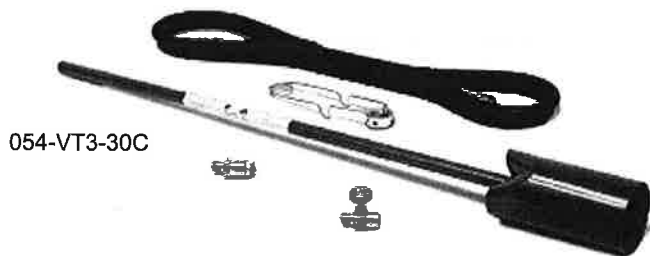

## Torch Kits

### VT 3-30 C 500,000 BTU Vapor Torch Kit

The VT 3-30 C is our most versatile "weed burner" and the most popular torch kit in America. At 500,000 BTU/hr., this kit really delivers the heat for weed burning, thawing, heating, or whatever the job may require. A 28" handle and all-new flame adjusting valve make the VT 3-30 C our deluxe torch of choice for farmers, ranchers, construction professionals and property owners.



054-VT3-30C

#### CSA Certified Kit Includes:

- 500,000 BTU vapor torch
- 10' U.L. listed LP gas hose
- U.L. listed safety P.O.L. fitting
- Adjustable needle valve
- Spark lighter
- Pipe thread compound

#### VT 3-30 Vapor Torch Specifications:

Maximum capacity	500,000 BTU/Hr.
Normal operating pressure	.30 PSI
Operating pressure Range	.5 - 90 PSI
Approx. flame temperature	2050° F
Fuel consumption @ 30 PSI	10.13 Lbs./Hr.
Max fuel consumption	23.3 Lbs./Hr.
Fuel inlet	1/4" NPT
Torch bell diameter	.3"
Handle length	.28"
Overall torch length	.33-1/2"

Part No.	Description	Std. Pkg.
054-VT3-30C	Model: VT 3-30 C Torch Kit	6

### VT 2-1/2 - 24 CE 500,000 BTU Economy Torch Kit

This kit has a great low price and really delivers at 500,000 BTU/hr. To save on cost, we use a shorter handle, thermoplastic rubber hose and a lower priced needle valve.

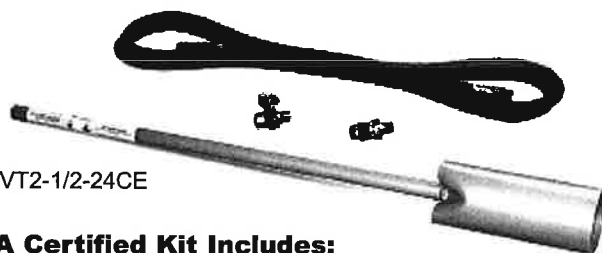

054-VT2-1/2-24CE

#### CSA Certified Kit Includes:

- 500,000 BTU torch
- 10' U.L. listed LP gas hose
- U.L. listed excess flow P.O.L. fitting
- Flame adjustable needle valve
- Pipe thread compound

#### VT 2-1/2-24 CE Vapor Torch Specifications:

Maximum capacity	500,000 BTU/Hr.
Normal operating pressure	.30 PSI
Operating pressure Range	.5 - 90 PSI
Approx. flame temperature	2050° F
Fuel consumption @ 25 PSI	10.13 Lbs./Hr.
Max fuel consumption	23.3 Lbs./Hr.
Fuel inlet	1/4" NPT
Torch bell diameter	.2-1/2"
Handle length	.23"
Overall torch length	.27-1/2"

Part No.	Description	Std. Pkg.
054-VT2-1/2-24 CE	Model: VT 2-1/2-24 CE	24

## P.O.L. Fittings

### Excess Flow P.O.L.

A soft-nose P.O.L. connector incorporates an excess flow safety device and hex nut for positive tightening. The outlet on this fitting is 1/4" male pipe thread. Flow rate is 1.8 gallons per minute.



Part No.	Description	Std. Pkg.
054-P-3200W	Excess Flow P.O.L. 1/4" MPT Fitting	1



## P.O.L. Fittings (Cont.)

### Standard P.O.L.

The fitting that adapts most LP cylinders to regulators and other fittings. The P.O.L. nut is the left hand fitting that threads into nearly all butane/propane cylinders and the other end of this connection is standard 1/4" male pipe thread. This is a straight through flow design - **No excess flow safety device installed in this P.O.L.**



Part No.	Description	Std. Pkg.
054-P1685	Standard Flow P.O.L. 1/4" MPT Fitting	10/Case

## LP Hose Assemblies

### HP-Series LP-Gas Hose - Liquid or Vapor

HP-series hose is U.L. listed for use with either vapor or liquid LP-gas and is available in 5', 10', 25' and 50' lengths. Each hose is coupled with 1/4" male pipe thread fittings on both ends\*. Maximum working pressure of this hose is 350 PSI with a burst test of 1750 PSI. Hose I.D. is 1/4". A 1/4" female brass coupling is included with each hose.



\* HP-10 C comes with one female end and one male end.

Part No.	Description	Std. Pkg.
054-HP-10C	10' Hose with 1/4" MPT & 1/4" FPT	10/Case

## Needle Valves

### All Brass Adjusting Needle Valve

This heavy-duty needle valve has been tested in excess of 350 lbs. and incorporates a thumb wheel for easy open or close. Both inlet (female end) and outlet (male end) are 1/4" standard pipe thread.



Part No.	Description	Std. Pkg.
054-V-334	Needle Valve 1/4" Standard Pipe Thread	10/Case

### Adjusting Needle Valve

A less expensive needle valve for use with LP-gas, air or water and other fluids. Both inlet (female end) and outlet (male end) are 1/4" standard pipe thread. This replaces the old V-3055 P needle valve with "T" handle.



Part No.	Description	Std. Pkg.
054-V-3055	Needle Valve 1/4" Standard Pipe Thread	10/Case

# RIDGID®

Tools For The Professional™

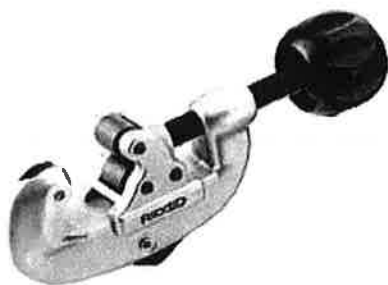
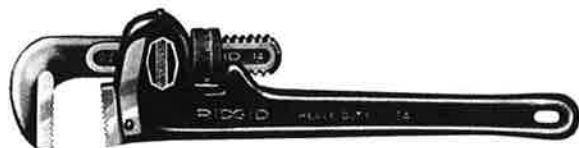

## ROTHENBERGER

### Pliers

#### Rolock® Pliers

The Rolock® Pliers, a professional-grade water pump pliers with jaw locking system, provide a secure grip on round, square or hex-shaped items with the push of a button.

- Multi-purpose jaws grip round, flat, square or hex items
- 14 groove opening positions: opening capacity of 2-1/3"
- Patented enclosed, adjusting lock system provides fast selection of the opening size with the touch of a button
- Non-slip, rubber handle grips: secure, anti-slip
- Durable, double-hardened, chrome vanadium steel with black oxide finish: resists corrosion

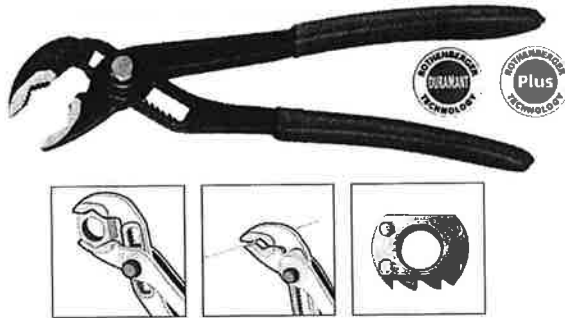

Part No.	Description / Length	Lb.
120-70532	Rolock® 10" Pliers	0.8
120-70533	Rolock® 12" Pliers	1.0

### Pliers

#### Water Pump Pliers

Complies with DIN 5231 D, with heavy duty box joint, chrome vanadium steel, drop forged, tempered, polished head and joint.

- Self-clamping jaws won't slip, even on smooth surfaces
- Asymmetrical gripping surfaces, rhombus-shaped: optimum grip
- Induction hardened teeth with high wear resistance: long service life
- Adjustable for 7 sizes, stable, tough: variable use
- Ergonomically shaped anti-slip, plastic covered legs: firmer grip
- Longer, thinner pliers with measurements for corners: ideal for hard to reach places
- Crush and clamp guard: protects fingers



Part No.	Length	Max. O.D.	Lb.
120-70521	7"	1"	0.5
120-70522	10"	1-1/4"	0.8
120-70523	12"	1-1/2"	0.1

## ROTHENBERGER

### Pipe Wrenches

#### Heavy Duty Pipe Wrench

Monoblock cast body with high strength, double T profile, forged jaw and hook, fine-polished teeth set against turning direction, induction hardened, tempered, and anti-slip adjustment screw. Complies with US standard GGG-W-651 Type 1 Class A.

- Spring-support hook: one-handed ratchet-like use, self-clamping
- Quick preset of tube diameter using scale on hook, simple presetting



Part No.	Length	Max. O.D.	Lb.
120-70150	8"	1/2"	1.0
120-70151	10"	1-1/2"	2.0
120-70152	12"	2"	3.5
120-70153	14"	2"	4.5
120-70154	18"	2-1/2"	6.5
120-70155	24"	3"	10.5
120-70156	36"	5"	20.0
120-70157	48"	6"	37.0

#### Aluminum Pipe Wrench

Features similar to heavy duty. Complies with US standard GGG-W-651 Type I Class B.

- Extremely light aluminum alloy with high strength: approx. 40% lighter



Part No.	Length	Max. O.D.	Lb.
120-70159	10"	1-1/2"	2.0
120-70160	14"	2"	3.0
120-70161	18"	2-1/2"	4.0
120-70162	24"	3"	6.0
120-70163	36"	5"	11.5
120-70164	48"	6"	20.0

### Pipe Wrenches / Chain Wrenches

#### Heavy Duty End Pipe Wrench

Features similar to heavy duty. Complies with US standard GGG-W-651 Type IV.

- Offset wrench head: ideal for work in confined spaces or close to walls



Part No.	Length	Max. O.D.	Lb.
120-70166	10"	1-1/2"	1.7
120-70167	14"	2"	3.2

## ROTHENBERGER

### Pipe Wrenches / Chain Wrenches (Cont.)

#### Aluminum Offset Pipe Wrench

Features similar to heavy duty. Complies with US standard GGG-W-651 Type I Class B.

- Extremely light aluminum alloy with high strength: approx. 40% lighter
- Offset wrench head: ideal for work in confined spaces or close to walls



Part No.	Length	Max. O.D.	Lb.
120-70115	14"	2"	3.0
120-70116	18"	2-1/2"	4.0

#### Chain Pipe Wrench 4"

Profile handle made of drop forged, chrome vanadium steel, polished head and powerful chain made of tempered special steel.

- With a double-sided teeth surface set against the turning direction: works in both directions without re-inserting



Part No.	Length	Max. O.D.	Lb.
120-70235	12"	4"	2.0

#### Heavy Duty Chain Pipe Wrench

Very tough design for the most demanding applications, tried and test in pipeline construction. Forged jaws and handle; replaceable jaws.

- Strong chain made of tempered special steel: fits every cross-section
- Double-sided tooth system for ratchet-like use: for right and left-handed motion



Part No.	Length	Max. O.D.	Lb.
120-70243	27"	2-1/2"	6.0
120-70244	37"	4"	12.0
120-70245	44"	6"	25.0
120-70246	50"	8"	33.0
120-70247	63"	12"	62.0

#### Replacement Parts



Hook Jaw Part No.	Heel Jaw & Pin Part No.	Nut Part No.	Set of Springs Part No.	Wrench Size
120-70200	120-70190	120-70180	120-70170	8"
120-70201	120-70191	120-70181	120-70171	10"
120-70202	120-70192	120-70182	120-70172	12"
120-70203	120-70193	120-70183	1207-0173	14"
120-70204	120-70194	120-70184	120-70174	18"
120-70205	120-70195	120-70185	120-70175	24"
120-70206	120-70196	120-70186	120-70176	36"
120-70207	120-70197	120-70187	120-70177	48"

## ROTHENBERGER

### Tube Cutters

#### Pro 35 / Pro 42 Tube Cutter

Cuts tubes made of: copper, brass, aluminum, thin-walled steel PE, PP, PVDF, plastic-coated tubes, stainless steel.

- Two guide rollers with recess: for cuts near flares
- Constant, tight working radius of 4-7/8" (123 mm), perfect for confined spaces
- Exact telescopic guide: precise cut
- Easy to turn adjustment knob: quick adjusting of the working area
- Retractable internal tube deburrer: always within reach
- Metal casing with Duramant® coating: strong and extremely stable
- Spare cutter wheel in handle: immediately available when needed (120-70027 only)



Part No.	Description	Max. O.D.	Lb.
<b>For Copper, Aluminum</b>			
120-70027	Pro 35	1/4" - 1-3/8"	1.0
120-70017B	Cutter Wheel, 2 Pk.	-	0.3
120-70017D	Cutter Wheel, 5 Pk.	-	0.3
<b>For Stainless Steel</b>			
120-70055	Pro 35 SS	1/4" - 1-3/8"	1.1
120-70070	Pro 42 SS	1/4" - 1-5/8"	1.2

### Tube Cutters (Cont.)

#### Minicut 2000

Tube cutter for copper tubes. Ergonomic design of body and knob with seating surface for the hand during turning.

- Large knurled knob, handy design: fatigue-free pressure control
- Two guide rollers with recess: cuts close to flares
- Handy design with small working radius of 1-3/4" (45 mm): ideal for hard to reach places



Part No.	Description	O.D.	Lb.
120-70105	Minicut 2000	1/8" - 7/8"	0.4
120-70017B	Cutter Wheel, 2 Pk.	-	0.1
120-70017D	Cutter Wheel, 5 Pk.	-	0.6

#### Mini Max

Tube cutter for copper tubes. Ergonomic design of body and knob with seating surface for the hand during turning.

- Large knurled knob, handy design: fatigue-free pressure control
- Two guide rollers with recess: cuts close to flares
- Handy design with small working radius of 1-3/4" (45 mm): ideal for hard to reach places



Part No.	Description	O.D.	Lb.
120-70015	Mini Max 1/8"	1-1/8"	0.8
120-70017B	Cutter Wheel, 2 Pk.	-	0.1
120-70017D	Cutter Wheel, 5 Pk.	-	0.6

## ROTHENBERGER

### Tube Cutters (Cont.)

#### Rotrac Tube Cutters

High precision tube cutter for copper tubes.

- Improved design provides smooth-running, telescopic action: consistent working radius, blade advances faster
- Rotrac Plus cutters feature a large, knurled knob easier to run
- Rolling stop: protection of cutter wheel
- Protected screw spindle: prevents dirt ingress and jamming
- Cast aluminum design: compact and light

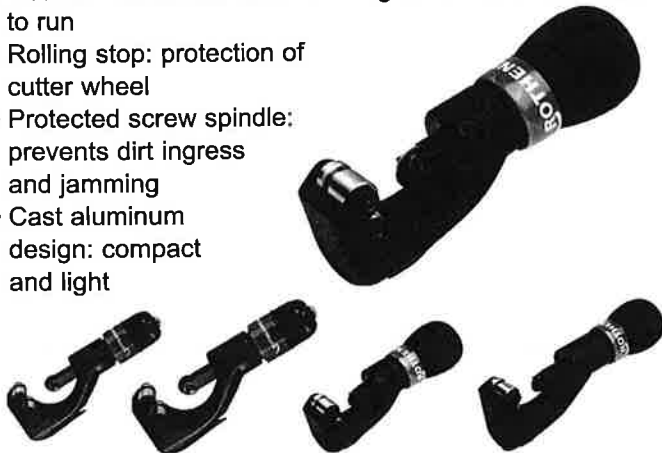

120-70010      120-70011      120-70020      120-70021

Part No.	Description	O.D.	Lb.
120-70010	Rotrac 28	1/8" - 1-1/8"	1.0
120-70011	Rotrac 42	1/4" - 1-5/8"	1.0
120-70020	Rotrac 28 Plus	1/8" - 1-1/8"	1.0
120-70021	Rotrac 42 Plus	1/4" - 1-5/8"	1.0

### Pipe Cutters

#### 1-1/4" and 2" Steel Pipe Cutter

- Wide rollers: secure guiding of cutter wheel on tube
- Easy pressure control: optimum force transmission onto tube
- Hardened cutter wheel made of high alloy steel: long service life
- Burr-free external cutting: immediate thread cutting possible
- Optional cutter wheel for cast iron pipes
- 1/8" - 2" pipe cutter for plastic coated pipe



Part No.	Description	O.D.	Lb.
120-70040	1-1/4" Pipe Cutter	1/8" - 1-1/4"	2.5
120-70046D	Cutter Wheel, 1-1/4", 3 Ea.		0.5
120-70045	2" Pipe Cutter	1/8" - 2"	5.5
120-70051D	Cutter Wheel, 2", 3 Ea.		0.5
120-P70045C	2" Pipe Cutter for Plastic Coated Pipe	1/8" - 2"	5.5

### Pipe Cutters

#### 4" Steel Pipe Cutter

- Wide rollers: secure guiding of cutter wheel on tube
- Easy pressure control: optimum force transmission onto tube
- Hardened cutter wheel made of high alloy steel: long service life
- Burr-free external cutting: immediate thread cutting possible
- Optional cutter wheel for cast iron pipes



Part No.	Description	O.D.	Lb.
120-70060	4" Pipe Cutter	2" - 4"	17.0
120-70061D	Cutter Wheel, 4", 2 Ea.		0.5

#### Stainless Steel Pipe Cutters

For exact cutting of stainless steel tubes

- Hardened cutter wheel made of high alloy steel: long service life
- Burr-free external cutting: immediate thread cutting possible



Part No.	Description	O.D.	Lb.
120-70086	1-1/4" Stainless Steel Pipe Cutter	1/8" - 1-1/4"	2.4
120-70088	Cutter Wheel, 1-1/4"		0.1

### Plastic Pipe Shears

#### Rocut® Professional 50TC

Plastic pipe shears for precise cutting of PVC, PP, PE, PEX, PB and CPVC pipes up to 2" diameter.



Part No.	Description	Max. Sch. 40 PVC	Max. O.D.	Lb.
120-52010	Rocut® 50TC	1-1/2"	2"	1.4
120-52011	Spare Stainless Steel Blade			0.4



## ROTHENBERGER

### Plastic Pipe Shears (Cont.)

#### Rocut® Professional 75TC

Plastic pipe shears for precise cutting of PVC, PP, PE, PEX, PB and CPVC pipes up to 3" diameter.



Part No.	Description	Max. Sch. 40 PVC	Max. O.D.	Lb.
120-52015	Rocut® 75TC 2-1/2"	3"	3.6	
120-52016	Spare Stainless Steel Blade			0.5

### Economy Plastic Pipe Shears

Standard action cutters provide a fast, clean cut on most types of plastic pipes.



Part No.	Description	Max. Sch. 40 PVC	Max. O.D.	Lb.
120-55090E	Rocut® 32	1"	1-1/8"	1.2
120-55091E	Rocut® 42	1-1/4"	1-5/8"	1.6
120-55095E	Rocut® 63	2"	2"	3.5
129-50032	Replacement Blade for Rocut® 32			0.5
129-50042	Replacement Blade for Rocut® 42			0.8
129-50063	Replacement Blade for Rocut® 63			1.5

### Deburring Tools

#### Universal Internal/External Deburring Tools

Quick and easy deburring. For copper, steel and stainless steel, with polished cutting bit made of hardened special steel, smooth-running.



Part No.	Description	O.D.	Lb.
120-11006	For Copper and Plastic	1/8" - 1-3/8"	0.3

### Pipe Reamer

#### Ratchet Pipe Reamer 1/4" - 2"

Rapid and clean deburring. For steel tubes, with smooth-running ratchet, cutting bit made of tempered steel.



Part No.	Description	O.D.	Lb.
120-70289	Ratchet Internal Reamer Blade	1/4" - 2"	5.9
120-70296	Spare Reamer Blade		0.5

### Nut Wrench

#### Standard Basin Nut Wrench

Chrome-plated, with pivoted reversible jaw



Part No.	Description	Lb.
120-70236	Basin Nut Wrench, 3/8" - 1-1/4"	2.0

## ROTHENBERGER

### Strap and Fittings Wrench

Made of special aluminum alloy, with replaceable nylon strap.

- Safe to use on chrome-plated fittings: no damage to polished surfaces

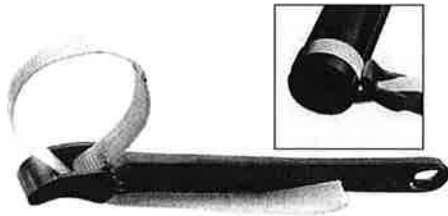

Part No.	Length	Max. O.D.	Lb.
120-70240	12"	3"	1.0
120-70241	12"	8"	1.3

### Robolt Bolt Cutter

Effort saving cutting of construction steel up to 1,300 N/mm<sup>2</sup> (HRC 40), gate steel, concrete steel type, I, II, III, IV, prestressed concrete steel and steel wires.

- Joint made of tempered steel, drop forged: long service life
- Cutting bit made of manganese vanadium steel, induction hardened: hardness HRC 55/60
- Rubber handles: secure, anti-slip grip



Part No.	Length	Cutting performance dia. mm		Lb.
		490 N/mm <sup>2</sup>	1300 N/mm <sup>2</sup>	
120-75011	14"	1/4"	3/16"	2.2
120-75013	24"	3/8"	5/16"	5.8
120-75015	36"	5/8"	3/8"	13.7

## Wrenches

### Adjustable Wrenches

Chrome vanadium steel, drop forged, chrome-plated and polished.

- Smooth-running, robust roller with minimum play in the sliding guides: precise work



Part No.	Length	Lb.
120-70441	6"	0.5
120-70442	8"	0.8
120-70443	10"	1.0
120-70444	12"	1.5
120-70445	15"	2.5

### Speed Wrenches

The ideal multi-function spanner with ratchet function - for almost all screw applications up to a size of 1-1/4" (42 mm)

- Self-clamping even on smooth tubes, bolts and shafts, heads of hexagonal screws: enormous leverage



Part No.	Clamping Width Length	O.D.	Lb.
120-70220	6"	1/8" - 3/8"	0.2
120-70221	8"	1/4" - 3/4"	0.5
120-70222	10"	3/8" - 1"	0.8
120-70223	12"	1/2" - 1-1/4"	1.2

## ROTHENBERGER

### Vises

#### Bench Yoke Vise

Foldable, with automatic closing hook, milled and hardened upper and lower support jaw, powerful smooth-running spindle.



Part No.	Description	Lb.
120-70711	Bench Yoke Vise, 1/8" - 4" O.D.	25.0

#### Tribench with 6" Chain Vise

- Sturdy, one-piece steel frame: easily folds for transport
- Includes holes and slots: for bending, cutting, or attaching tools
- Integrated chain vise: up to 6" pipe capacity
- Interchangeable jaws: works with Ridgid® 460 model
- Ceiling brace for overhead support of the stand: secure frame even during difficult work



Part No.	Description	O.D.	Lb.
120-70752	Tribench with Chain Vise	1/8" - 6"	48.0

#### Top Screw Cam Lock Vise

Tough, powerful, bending device and tube support, forged and hardened, wear-resistant jaws, powerful chain.

- V-shaped support: prevents bending during clamping
- Universal vise attachment
- Offset lever and pre-tensioning screw: quick fastening



Part No.	Description	O.D.	Lb.
120-70716	Top Screw Cam Lock Vise	1/8" - 6"	20.5

### Benders

#### Tube Bender Maxi

Universal application possibilities in plumbing and heating installations, refrigeration, climate control, floor heating and hydraulic systems.

- Universal supports: for bending of cooper or non-coated tubes
- Pliers with bayonet catch: bending formers easily changeable
- Open bending frame: production of repeated alternate angled bends possible
- Smooth-running feed lever: ideal in restricted spaces and for one handed operation
- Plastic bending formers and supports with low friction: optimum bending results
- Body made of diecast steel: tough and long-lasting
- Side lever: quick release and reset of bending former



Set includes: basic tool (23000), bending support (23001), bending formers, and steel case



Part No.	Description	Lb.
120-23022	Maxi Bender Set, 3/8", 1/2", 5/8", 3/4", 7/8"	8.5

#### Standard Two Handed Bender

For exact bending up to 180° of tubes made of

- Soft copper and aluminum
- Bending radius display of 0 - 180° on former: exact bending
- Clamp mechanism for tighter tube hold: for bending shorter tube pieces
- Light construction: fatigue-free hand operation



Part No.	O.D.	R Radius In.	Length	Lb.
120-25140	1/4"	0.71	12.0"	1.3
120-25131	5/16"	0.95	12.0"	1.5
120-25141	3/8"	1.18	15.4"	2.0
120-25142	1/2"	1.65	15.4"	3.8
120-25136	5/8"	2.28	17.7"	4.0

## ROTHENBERGER

### Benders (Cont.)

#### Multibender

Universal hand bender provides bending of 1/2", 5/8", 3/4" and 7/8" O.D. with 1 tool. Ideal for soft copper and aluminum.



Part No.	Description	O.D.	Lb.
120-90614	Multibender	1/2", 5/8", 3/4", 7/8"	8.7

#### Minibend

For exact, two-handed bending up to 180° of tubes made of:

- Compact design: three tube sizes with tight bending radii
- Minimum measurement and bending radius display on former: exact bending possible
- Soft copper, brass, aluminum
- Suitable for use in: refrigeration, climate control, oil supply, automobile, hydraulic and air pressure systems

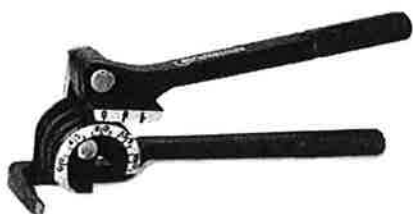

Part No.	Description	O.D.	Lb.
120-25151	Minibend	1/4", 5/16", 3/8"	1.0

### Power Threader Adapters

#### Adapters for Supertronic 2000

Fits small external octagonal die heads from 1/4" to 1-1/4"



Part No.	Description	Lb.
120-71273	Monoblock Adapter	2.0

### Hand Threaders

#### Super Cut Ratchet Threader

##### Quick change die heads

- Positive octagonal universal drive: secure hold
- Long pipe guide: perfect centering

##### Precision dies

- High-quality tempered steel: extremely long life
- Optimized cutting geometry: easy to start cut, excellent chip discharge

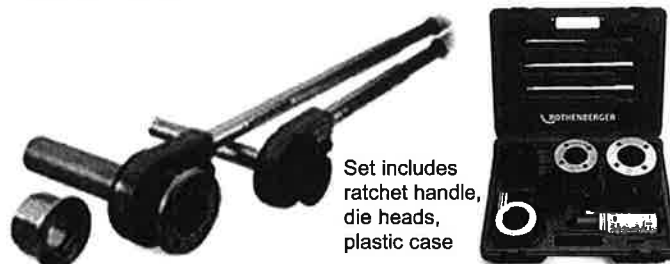

Set includes ratchet handle, die heads, plastic case

Part No.	Description	Lb.
120-70905X	Super Cut Set, 1/2", 3/4", 1", 1-1/4", 1-1/2", 2" NPT	20.0
120-71273	Die Head Adapter for Die Heads up to 1-1/4"	2.0

### Portable Power Threaders

#### Supertronic 2000 Power Threader

- Large mechanism for switching direction: reverses direction when thread is complete
- Hardened teeth and jaws on support arm: secure grip in both turning directions
- Offset die head mounting: allows threading close to walls
- Direct seating with locking of tension ring: die heads are held firmly in place
- Compact gear housing with excellent overall size: ideal for difficult to reach positions (corners, shafts)



Set includes Supertronic 2000 economy, forged pipe clamp (71280), precision die heads, plastic case

Part No.	Description	Lb.
120-71259L	Supertronic 2000 Set, 1/2", 3/4", 1", 1-1/4", 1-1/2", 2" NPT	42.1

## ROTHENBERGER

### Power Drivers

#### Mini-Collins®

Puts power back into power threading - thread up to 2" pipe or conduit, 1" bolt or rod, in seconds.



120-00074

Part No.	Description	Lb.
120-00074	Mini-Collins® Drive, 115V	27.0

#### Pneumatic Mini-Collins®

Rothenberger's Pneumatic Mini-Collins weighs only 27 pounds and is the most portable air-powered threader available.

- For complete safety in hazardous environments such as petroleum and chemical plants, mines or tunnels
- Reversible, non-sparking air motor develops 500 foot-pounds of torque in either direction

Cannot be damaged by overload, even when operated to point of stall



120-00078

Part No.	Description	Lb.
120-00078	Pneumatic Mini-Collins® Drive	29.0

### Compact Threading Machines

#### Ropower 50R

Rothenberger's portable 2" threading machines offer fast and steady, precision threading, cutting, de-burring, and grooving. The powerful 750-watt (1 HP) motor provides strong turning power with consistent torque for swift, effortless production of accurate, standard pipe and bolt threads. The optional foldable, wheeled workbench makes transport easy, weather on site or in the workshop. Replacing the dies is fast and easy due to unique ball-detent feature.

The Ropower 50R uses Ridgid® compatible dies with the new quick-change ball detent feature. While other manufacturers' Ridgid® style dies may be used in the 50R die head (56265), only Rothenberger's dies snap into position.

Standard supply: Ropower 50R, automatic die head 1/2" - 2" (56265), alloy NPT dies (1/2" - 3/4" 89162 and 1" - 2" 86163), set of 4 legs, safety foot switch, 1 gallon Rocool® oil (01922).

\* Ridgid® is a registered trademark of Ridge Tool Co.

- Smooth action impact hammer chuck: pipes don't slip
- Automatic die head with through-the-head oiling: easy to use
- Rear centering chuck: for axial alignment of the pipe
- Ball detent dies: quick and easy to change
- Interior deburrer, snap in, 3-blade: burr-free work
- Sturdy oil pump with high flow power and adjustable fluid quantities, filter system, integrated oil feed: optimal lubrication and cooling
- Large plastic shavings collection trough: easy to clean
- Dual-sided tool guide: precise guiding
- Work spindle with closed bearings on both sides: low-wear and precise guiding



Part No.	Description	Lb.
120-63005	Ropower 50R with Automatic Die Head with NPT Alloy dies 1/2" - 2"	97.0

## ROTHENBERGER

### Compact Threading Machines (Cont.)

#### Supertronic 4SE 4" Threading Machine

##### Threading head

- Automatic die head: ensures proper thread length and depth
- Automatic oil feed: provides ideal lubrication and cooling to maximize die life
- Self-centering pipe cutter: quickly cuts pipe to length
- Snap-lock internal, triple de-burring blade: removes sharp edges
- Oil-resistant power cable: long life
- Ball detent dies: quick and easy to change
- Large, plastic chip tray: catches chips and is easy to clean

##### Additional features

- Rear centering chuck: for correct axial alignment
- Smooth action impact hammer chuck: powerful, no-slip grip
- Dual tool/feed slide with geared indexing
- Strong, precise work spindle is guided on both sides by enclosed ball bearings
- Safety foot switch: stops motor in case of emergency



Part No.	Description	Lb.
120-63006	Supertronic 4SE 1/2" - 4"	232.0
120-89101	Alloy Die Set 1/2" - 3/4" NPT	2.0
120-89102	Alloy Die Set 1" - 2" NPT	2.0
120-59912	Alloy Die Set for Die Head 64350 only 2-1/2" - 4" NPT	3.0
120-01922	Rocool Thread Cutting Oil 1 Gallon	8.0
120-04510	Cutter Wheel	0.5

### Pipe Stands

#### Superjack Pipe Stands

Supports full lengths of pipe, 1/2" - 8", when using pipe threading machines

- Height capacity: 27" - 50"
- Weight capacity: 2,500 lb. max
- Folding stand includes carrying handle

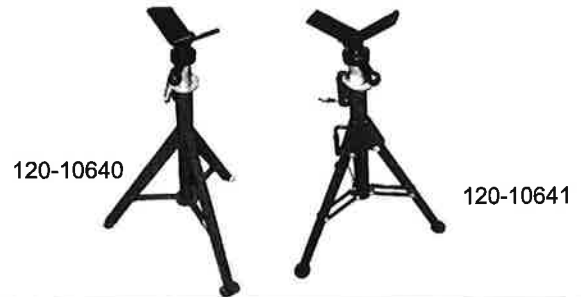

Part No.	Description	Lb.
120-10640	Superjack with V-Head	25.0
120-10641	Folding Superjack with V-Head	26.0



### Coolers

- Durable construction
- Resists scratching, denting, and fading
- Drip-resistant spigot, and screw-tight lid
- Extra-thick insulation ensures thermal retention
- Stain and odor resistant, easy-to-clean liner



Part No.	Description	Std. Pkg.
173-156006	Rubbermaid 1 Gallon Victory Jug	1
173-153004	Rubbermaid 2 Gallon Jug	1
173-168301	Rubbermaid 3 Gallon Jug	1
173-168501	Rubbermaid 5 Gallon Jug	1
173-165501	Rubbermaid 7 Gallon Jug	1
173-161001	Rubbermaid 10 Gallon Jug	1

## Rubbermaid®

### Ice Chests & Accessories

48 Quart Ice Chest

Cup Dispenser



Part No.	Description	Std. Pkg.
173-184802MODRD	Rubbermaid 48 Quart Red Ice Chest	1
173-184802MODBL	Rubbermaid 48 Quart Blue Ice Chest	1
173-825706	Cup Dispenser	1

Replacement Lids

Replacement Spigots



Part No.	Description	Std. Pkg.
173-040306	Rubbermaid 3 Gallon Replacement Lid	1
173-040506	Rubbermaid 5 Gallon Replacement Lid	1
173-097606	Rubbermaid 10 Gallon Replacement Lid	1
173-053801	Rubbermaid Replacement Spigot	1
173-0580WW	Rubbermaid 2B87T8WHT Spigot	1

### Storage Containers

#### ActionPacker® Storage Containers

- Rugged construction
- Tough, lockable latches (lock not included)
- Easy bungee cord tie-down



173-117004

Part No.	Description	Std. Pkg.
173-117004	8 Gal., 19.9" x 14.1" x 12.1" Storage Container	1

### Storage Containers (Cont.)



173-117202



173-119101



173-119201



173-198200

Part No.	Description	Std. Pkg.
173-117202	Rubbermaid 24 Gal., 26.5" x 19" x 17.4" Container	1
173-119101	Rubbermaid 35 Gal., 34.5" x 18.5" x 16.375" Container	1
173-119201	Rubbermaid 48 Gal., 43.8" x 20" x 17" Container	1
173-198200	Rubbermaid 102 Quart Marine Container	1?

### Universal Mounting



Part No.	Description	Std. Pkg.
173-1640-02-331	Rubbermaid Universal Mounting	1

## **RUST-OLEUM®** INDUSTRIAL BRANDS

### V2100 System

#### Galvanizing Compound Aerosol



- Excellent adhesion to galvanized metal
- Dries fast - 20 minutes to touch
- Maximum corrosion protection ideal for use in moderate to severe environments
- Can be used on surfaces that reach temperatures up to 200°F
- USDA acceptable and Agriculture Canada approved

Part No.	Description/ Colors	Std. Pkg.
209-V2185838	Cold Galvanizing Compound	6/Case
209-V2117838	Bright Galvanizing compound	6/Case

#### High Heat Coating Aerosol



- Direct-to-metal (DTM) spray protects against corrosion
- Dries fast - 20 minutes to touch
- Durable, long-lasting finish
- USDA acceptable and Agriculture Canada approved

Part No.	Description/ Colors	Std. Pkg.
209-V2116838	High Heat Aluminum	6/Case
209-V2176838	High Heat Black	6/Case

### 7400 System

#### 769® Damp Proof Red Primer



- Minimizes prep time - apply direct-to-rust
- Superior adhesion to sound, rusted metal
- Protects against further rust and corrosion
- USDA acceptable and Agriculture Canada approved

Part No.	Description/ Colors	Std. Pkg.
209-769402	1 Gallon, Damp-Proof Red Primer	2/Pack

### 7400 System (Cont.)

#### Quick Dry Primers



- Tack-free in 30-60 minutes when spray applied
- Can be exposed up to 6 months without topcoating
- USDA acceptable

Part No.	Description/ Colors	Std. Pkg.
209-7086402	1 Gallon, Gray	2/Pack
209-678402	1 Gallon, Red	2/Pack

### V7400 System

#### DTM 340 VOC Alkyd Enamel



- Excellent coverage in one coat
- High solids content provides better coverage compared to competitive enamels
- High gloss, durable finish that provides good color and gloss retention
- Superior resistance to chipping, cracking and peeling
- Protects against mid chemical spills, fumes, oil and grease

Part No.	Color	Std. Pkg.
209-245382	1 Gallon, Dunes Tan	2/Pack
209-245380	1 Gallon, Chestnut Brown	2/Pack
209-245441	1 Gallon, National Blue	2/Pack
209-245487	1 Gallon, Vista Green	2/Pack
209-245388	1 Gallon, Forest Green	2/Pack
209-245482	1 Gallon, Semi-Gloss Pleasant Green	2/Pack
209-245400	1 Gallon, John Deere Green	2/Pack
209-245488	1 Gallon, Yellow	2/Pack
209-245500	1 Gallon, Old Caterpillar Yellow	2/Pack
209-245489	1 Gallon, New Caterpillar Yellow	2/Pack
209-245385	1 Gallon, Fire Hydrant Red	2/Pack
209-245443	1 Gallon, Navy Gray	2/Pack
209-245484	1 Gallon, Silver Gray	2/Pack
209-245309	1 Gallon, Aluminum	2/Pack
209-245403	1 Gallon, High Gloss Black	2/Pack
209-245406	1 Gallon, High Gloss White	2/Pack
209-245474	1 Gallon, Safety Blue	2/Pack
209-245477	1 Gallon, Safety Orange	2/Pack
209-245478	1 Gallon, Safety Red	2/Pack
209-245479	1 Gallon, Safety Yellow	2/Pack



## **RUST-OLEUM®** INDUSTRIAL BRANDS

### V7400 System (Cont.)

#### DTM 340 VOC Alkyd Enamel Primers



- Fast recoat; recoats in one hour
- Proven corrosion protection
- Superior adhesion
- USDA acceptable and Agriculture Canada pending

Part No.	Description/ Colors	Std. Pkg.
209-V769402	1 Gallon, Red	2/Pack

#### 340 VOC Fast Recoat Rust-Inhibitive Primer



- Quick Dry

Part No.	Description/ Colors	Std. Pkg.
209-V7086300	5 Gallon, Gray	1 Pail
209-V769300	5 Gallon, Red	1 Pail

#### DTM 340 VOC Alkyd Enamel



Part No.	Description/ Colors	Std. Pkg.
209-245405	5 Gallon, High Gloss Black	1 Pail
209-245407	5 Gallon, High Gloss White	1 Pail
209-245480	5 Gallon, Safety Yellow	1 Pail

### V7400 System (Cont.)

#### DTM 450 VOC Alkyd Enamel



Part No.	Description/ Colors	Std. Pkg.
209-2766300	5 Gallon, High Gloss White	1 Pail
209-634300	5 Gallon, High Gloss Black	1 Pail
209-641300	5 Gallon, Thinner	1 Pail
209-678300	5 Gallon, Quick Dry Red Primer	1 Pail
209-769300	5 Gallon Damp Proof Red Primer	1 Pail
209-944300	5 Gallon, Safety Yellow	1 Pail

### Thinners



Part No.	Description/ Colors	Std. Pkg.
209-333402	2 Gallon, Exempt Solvent	1
209-641402	2 Gallon, Spray Application	1

### M1800 System

#### Precision Line® Inverted Marking Paint



- Best resistance against premature fading
- Marks more linear feet per can than other brands
- No mess spray tip keeps paint off fingers
- Locking tip does not pop off
- Virtually no overspray
- Dries fast - less than 5 minutes
- Guaranteed not to clog

Part No.	Description/ Colors	Std. Pkg.
209-203036	1 Gallon, Fluorescent Orange	1

## **RUST-OLEUM®** INDUSTRIAL BRANDS V2100 System



### Rust-Preventive Enamel Aerosol

- Any-angle spray can be sprayed in any direction, even upside down
- New high output tip covers 50% faster, requiring less downtime
- Dries fast - 20 minutes to touch
- Can be used on surfaces that reach temperatures up to 200° F

Part No.	Description/ Color	Std. Pkg.
<b>Enamel</b>		
209-V2171838	15 Oz. Aerosol, Tan	6/Case
209-V2175838	15 Oz. Aerosol, Chestnut Brown	6/Case
209-V2125838	15 Oz. Aerosol, Deep Blue	6/Case
209-V2123838	15 Oz. Aerosol, Light Blue	6/Case
209-V2137838	15 Oz. Aerosol, Dark Green	6/Case
209-V2138838	15 Oz. Aerosol, Hunter Green	6/Case
209-V2147838	15 Oz. Aerosol, Industrial Yellow	6/Case
209-V2164838	15 Oz. Aerosol, Bright Red	6/Case
209-V2187838	15 Oz. Aerosol, Dark Machine Gray	6/Case
209-V2184838	15 Oz. Aerosol, Dove Gray	6/Case
209-V2183838	15 Oz. Aerosol, Light Machine Gray	6/Case
209-V2188838	15 Oz. Aerosol, Smoke Gray	6/Case
209-V2115838	15 Oz. Aerosol, Silver Aluminum	6/Case
209-V2179838	15 Oz. Aerosol, Gloss Black	6/Case
209-V2178838	15 Oz. Aerosol, Flat Black	6/Case
209-V2192838	15 Oz. Aerosol, Gloss White	6/Case
209-V2190838	15 Oz. Aerosol, Flat White	6/Case
<b>Safety</b>		
209-V2124838	15 Oz. Aerosol, Safety Blue	6/Case
209-V2133838	15 Oz. Aerosol, Safety Green	6/Case
209-V2155838	15 Oz. Aerosol, Safety Orange	6/Case
209-V2167838	15 Oz. Aerosol, Safety Purple	6/Case
209-V2163838	15 Oz. Aerosol, Safety Red	6/Case
209-V2143838	15 Oz. Aerosol, Safety Yellow	6/Case
<b>Fluorescent</b>		
209-2233838	14 Oz. Aerosol, Fluorescent Green	6/Case
209-2255838	14 Oz. Aerosol, Fluorescent Orange	6/Case
209-2264838	14 Oz. Aerosol, Fluorescent Red	6/Case
209-2242838	14 Oz. Aerosol, Fluorescent Yellow	6/Case
<b>Farm Equipment</b>		
209-209713	15 Oz. Aerosol, John Deere Green	6/Case
209-209714	15 Oz. Aerosol, John Deere Yellow	6/Case
209-209715	15 Oz. Aerosol, Caterpillar Yellow	6/Case
209-209716	15 Oz. Aerosol, Allis Chalmers Org.	6/Case
209-209717	15 Oz. Aerosol, Int'l Harvester Red	6/Case
209-209718	15 Oz. Aerosol, Ford Blue	6/Case
209-V2148838	15 Oz. Aerosol, Equipment Yellow	6/Case
209-V2156838	15 Oz. Aerosol, Equipment Orange	6/Case
<b>Companion Products</b>		
209-243456	15 Oz. Aerosol, Spray Grip	6/Case
209-241526	15 Oz. Aerosol, Comfort Grip	6/Case

### Enamel Primer Aerosol



- Fast-drying
- Can be topcoated any time
- Use anywhere extra protection is needed on rusted, bare or previously painted metal

Part No.	Description/ Colors	Std. Pkg.
209-V2169838	15 Oz. Aerosol, Red Primer	6/Case
209-V2182838	15 Oz. Aerosol, Gray Primer	6/Case
209-209566	15 Oz. Aerosol, White Clean Metal Primer	6/Case

### 7400 System

#### 450 VOC DTM Alkyd Enamel



- Rust-Oleum's original rust preventative direct-to-metal (DTM) coating
- Excellent coverage in one coat
- Protects against mild chemical spills, fumes, oil and grease
- USDA acceptable and Agriculture Canada approved

Part No.	Color	Std. Pkg.
209-865402	1 Gallon, Dunes Tan	2/Pack
209-977402	1 Gallon, Chestnut Brown	2/Pack
209-721402	1 Gallon, National Blue	2/Pack
209-866402	1 Gallon, Marlin Blue	2/Pack
209-935402	1 Gallon, Vista Green	2/Pack
209-1282402	1 Gallon, Forest Green	2/Pack
209-7232402	1 Gallon, Semi-Gloss Pleasant Green	2/Pack
209-7434402	1 Gallon, John Deere Green	2/Pack
209-7446402	1 Gallon, Yellow	2/Pack
209-7448402	1 Gallon, Old Caterpillar Yellow	2/Pack
209-7447402	1 Gallon, New Caterpillar Yellow	2/Pack
209-1210402	1 Gallon, Fire Hydrant Red	2/Pack
209-975402	1 Gallon, Navy Gray	2/Pack
209-906402	1 Gallon, Silver Gray	2/Pack
209-470402	1 Gallon, Aluminum	2/Pack
209-634402	1 Gallon, High Gloss Black	2/Pack
209-412402	1 Gallon, Flat Black	2/Pack
209-2766402	1 Gallon, High Gloss White	2/Pack
209-925402	1 Gallon, Safety Blue	2/Pack
209-933402	1 Gallon, Safety Green	2/Pack
209-956402	1 Gallon, Safety Orange	2/Pack
209-964402	1 Gallon, Safety Red	2/Pack
209-944402	1 Gallon, Safety Yellow	2/Pack



## Heavy Duty Contractor Bags



059-CDL5515



059-CCB750



059-CCB720

Part No.	Gallon Capacity	Gauge	Per Case Count	Units/Case	Color
059-CDL5515	55 Gallon	3.00 MIL	15	1	Black
059-CCB750	42 Gallon	3.00 MIL	50	1	Black
059-CCB720	42 Gallon	3.00 MIL	20	1	Black

# SAFETY-WAY™

## Type I - Safety Storage Cans

High quality terne plate safety cans offer a single spring closing spout cover for both filling and pouring and one hand opening actions to relieve internal vapor pressure before pouring. Type I cans are designed specifically for storage of flammable liquids.



Part No.	Description	Std. Pkg.
109-SC1000	1 Gallon Type I Safety Can	1
109-SC1025	2.5 Gallon Type I Safety Can	1
109-SC1030	3 Gallon Type I Safety Can	1
109-SC1050	5 Gallon Type I Safety Can	1
109-SC1050-YEL	5 Gallon Type I Safety Can, Yellow	1

## Type II - Safety Pour Storage Cans

Designed specifically for safely pouring flammable liquids without the spills. Made of high quality 22 gauge terne plate steel. Type II cans have two openings. One opening with a spring loaded cap for filling. The second opening has a pour mechanism mounted over it which provides totally enclosed vapor control flexible nozzle with spark-proof brass tip for accurate pouring.



Part No.	Description	Std. Pkg.
109-SC2000	1 Gallon Type II Safety Can	1
109-SC2025	2.5 Gallon Type II Safety Can	1
109-SC2030	3 Gallon Type II Safety Can	1
109-SC2050	5 Gallon Type II Safety Can	1

## Gas Can Accessories

### Type I Metal Pour Funnel

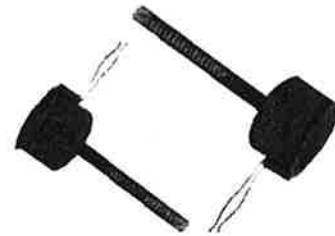

Part No.	Description	Std. Pkg.
109-F-346	3/4" x 6", Type I Funnel Fits 1 & 2 Gallon	1
109-F-347	3/4" x 10", Type I Funnel Fits 2-1/2, 3 & 5 Gallon	1

### Type II Metal Flex Hose



Part No.	Description	Std. Pkg.
109-R-3406	3/4" x 6", Type II Flex Hose Fits 1 & 2 Gal. Cans	1
109-R-3409	3/4" x 9", Type II Flex Hose Fits 2-1/2, 3, & 5 Gal. Cans	1
109-R-112	1" x 12", Type II Flex Hose	1

## SAFE-T-WAY™

Gas Can Accessories (Cont.)

### Point-N-Pour Polyethylene Funnel



Part No.	Description	Std. Pkg.
109-PPF-8	8-1/4" Type I Point-N-Pour Polyethylene Funnel	1

### Drum Plug Wrench



Part No.	Description	Std. Pkg.
109-DW-114	Drum Plug Wrench, Spark Resistant With 1.25" Open End Faucet Wrench	1

## SAR-GEL®



Part No.	Description	Std. Pkg.
193-SR160	Sar-Gel® 1 Oz. Tube Water Indicating Paste	12/case

## SCC

### Ratchet Straps & Tie Downs

All SCC heavy duty cargo strap assemblies are made from premium quality, strength tested, polyester webbing for maximum durability.

#### 1" Ratchet Tie Down with "S" Hooks

- Length: 15 ft.
- Width: 1"
- Web tensile strength: 4,500 lbs.
- Working load limit: 500 lbs.
- Assembly break strength: 1,500 lbs.



Part No.	Description	Width	Length	Std. Pkg.
099-CC1815	Ratchet Tie Down with "S" Hooks	1"	15'	10

#### 2" Wide Handle Ratchets

- Web tensile strength: 12,000 lbs.
- Assembly break strength: 10,000 lbs.
- Working load limit: 3,300 lbs.



With "J" Hooks



With Chain Hooks



With Flat Hooks

Part No.	Description	Width	Length	Std. Pkg.
099-CC2557	Wide Handle Ratchet w/Chain Hooks	2"	27'	8
099-CC2627	Wide Handle Ratchet w/Flat Hooks	2"	27'	8
099-CC2827	Wide Handle Ratchet w/"J" Hooks	2"	27'	8

# SCC

## Ratchet Straps & Tie Downs (Cont.)

### 3" Wide Handle Ratchets

- Web tensile strength: 15,000 lbs.
- Assembly break strength: 12,000 lbs.
- Working load limit: 4,000 lbs.

### 4" Wide Handle Ratchets

- Web tensile strength: 20,000 lbs.
- Assembly break strength: 15,000 lbs.
- Working load limit: 5,000 lbs.

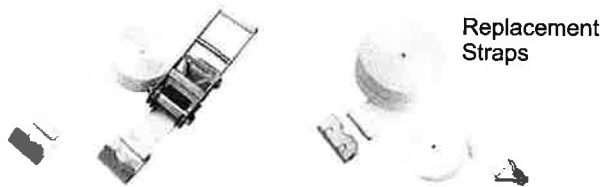

Replacement Straps

Part No.	Description	Width	Length	Std. Pkg.
099-CC4027	Ratchet Strap Assembly w/Flat Hooks	4"	27'	8
099-CC4730	Ratchet Strap Assembly w/Flat Hooks	4"	30'	4
099-CC9999	Wide Handle Ratchet w/Chain Hooks	3"	35'	1
099-CC3626	Wide Handle Ratchet w/Flat Hooks	3"	27'	4

## Lifting Slings

### Heavy Duty Class 7 Nylon

SCC's lifting slings are manufactured from premium nylon sling webbing and includes a stamped, heavy leather identification tag sewn securely to each sling.



### 1" Double Flat Eye Slings

Part No.	Width x Length	Std. Pkg.
099-SEE-2701-3	1" x 3'	1
099-SEE-2701-4	1" x 4'	1
099-SEE-2701-6	1" x 6'	1
099-SEE-2701-8	1" x 8'	1
099-SEE-2701-10	1" x 10'	1
099-SEE-2701-12	1" x 12'	1
099-SEE-2701-20S	1" x 20'	1

### 2" Double Flat Eye Slings

Part No.	Width x Length	Std. Pkg.
099-SEE-2702-3	2" x 3'	1
099-SEE-2702-4	2" x 4'	1
099-SEE-2702-6	2" x 6'	1
099-SEE-2702-8	2" x 8'	1
099-SEE-2702-10	2" x 10'	1
099-SEE-2702-12	2" x 12'	1
099-SEE-2702-20	2" x 20'	1

### 3" Double Flat Eye Slings

Part No.	Width x Length	Std. Pkg.
099-SEE-2703-6	3" x 6'	1
099-SEE-2703-8	3" x 8'	1
099-SEE-2703-12	3" x 12'	1

### 4" Double Flat Eye Slings

Part No.	Width x Length	Std. Pkg.
099-SEE-2704-4	4" x 4'	1
099-SEE-2704-6	4" x 6'	1
099-SEE-2704-8	4" x 8'	1
099-SEE-2704-10	4" x 10'	1

## Grab Hooks

- Drop forged
- Carbon steel hook
- Heat treated
- Use with system G3 proof coil or system G43 high test



Part No.	Description	Std. Pkg.
099-H7626-0411	1/4 Grade 43 C1 Grab Hook	10
099-H7626-0511	5/16 Grade 43 C1 Grab Hook	10
099-H7626-0611	3/8 Grade 43 C1 Grab Hook	10

## QuikBinder™

The SCC QuikBinder™ is easier to install than standard ratchet loadbinders. The 3-position pawl offers the user a choice of ratchet extension, ratchet take-up or a "free spin" setting for fast adjustment in either direction. A load can be secured in half the time. Features a vinyl coated barrel for strong, comfortable grip. The folding handle make SCC's QuikBinder™ safer (no handle sticking out) and more convenient to use.

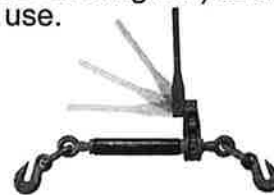

Part No.	Description	Std. Pkg.
099-H5125-0658	QuikBinder™ 5/16" - 3/8"	4
099-H5125-0858	QuikBinder™ 3/8" - 12"	4

## Sesamee®

### Keyless Padlocks

#### Brass Body

- 10,000 possible combinations
- Heel and toe locking
- All brass internal locking mechanism. Automatic "0000" stop. Full instructions furnished with each lock. Available carded from stock
- The combination is quickly and easily set and can be changed any time by the owner
- Material: Brass



021-K0436

Part No.	Description	Std. Pkg.
021-K436	5/16" x 1" Keyless Padlock	5
021-K437	5/16" x 2-1/4" Keyless Padlock	5
021-K0436	5/16" x 1" Keyless Padlock	5

#### Black Hardened Steel Jacket

- Industrial strength combination lock
- Resists hammer and re-bar attacks
- Hardened steel full metal jacket shroud
- Weather resistant black electrocoating



Part No.	Description	Std. Pkg.
021-K636	7/16" x 1" Keyless Padlock	5
021-K637	7/16" x 2-1/4" Keyless Padlock	5

## SEYMOUR®

QUALITY TOOLS SINCE 1872

### Eye Hoes

Feature large heavy blades best for heavy-duty digging and cultivating. American pattern.



103-2E-AEO

### Hardwood Handle



103-DG-AEH

Part No.	Description	Std. Pkg.
103-2E-AEO	7.5" x 7" Eye Hoes	6
103-DG-AEH	54" Handle for Eye Hoes	6

### Axes

#### Michigan Single Bit Axe

General purpose axe has a polished and beveled edges with premium fiberglass handle.



103-AX-3FG

#### Michigan Double Bit Axe

General purpose axe has a polished and beveled edge with premium fiberglass handle.

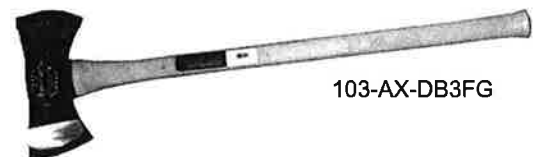

103-AX-DB3FG

Part No.	Description	Std. Pkg.
103-AX-3FG	Single Bit Michigan Axe	4
103-AX-DB3FG	Double Bit Michigan Axe	4

## SEYMOUR®

QUALITY TOOLS SINCE 1872

### Engineers Hammers

- Chamfered edges
- Shock-absorbing American hickory
- Turned-styled for better contours and grips



Part No.	Head	Handle
103-HE-3	3 Lb.	16" Hickory
103-HE-4	4 Lb.	16" Hickory



### Submersible Pumps

#### Geyser® Classic Submersible Pump.

- Heavy-duty aluminum construction
- 1320 max gallons per hour, 1/4 HP

139-2300



#### Smart Geyser® Submersible Pump

- Turns on and off automatically
- 1800 max gallons per hour, 1/4 HP
- Includes 15" power cord and garden hose adapter

139-2330



Part No.	HP	Max Gallons Per Hr	Std. Pkg.
139-2300	1/4	1320	4 Ea./CS
139-2330	1/4	1800	4 Ea./CS

### Submersible Pumps (Cont.)

#### Geyser® Submersible Thermoplastic Pump

- Rugged thermoplastic body
- Unplug from power source to shut off pump
- Includes 8' power cord and garden hose adapter

139-2305



Part No.	HP	Max Gallons Per Hr	Std. Pkg.
139-2305	1/4	1260	4 Ea./CS
139-2355	1/3	2160	4 Ea./CS

#### Mark Submersible Sump Pumps

- 1/3 HP
- Automatic float switch
- Rugged thermoplastic body
- Minimum 11" diameter sump basin
- 1-1/4 MNPT discharge

139-2955



139-2957

Part No.	Amps	Max Gallons Per Hr	Switch	Std. Pkg.
139-2955	10	2160	Tether	4 Ea./CS
139-2957	10	2160	Vertical	4 Ea./CS

#### Pud-L-Scoop® Pump

#### Mini Vac® with Pud-L-Scoop®

- Multi-purpose pump for emergency dewatering
- 450 max gallons/hr, 12 volts
- Pumps floor dry to 1/8"
- Not submersible
- Includes: pump, motor, 6' suction hose and Pud-L-Scoop®

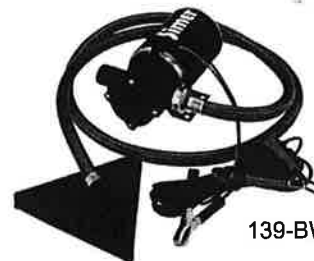

139-BW85P

Part No.	Volts	Max Gallons Per Hr	Std. Pkg.
139-BW85P	12	450	1



## File Handles - Skroo-Zon®



Part No.	Description	Std. Pkg.
106-73-992500	T2 - 4"	12
106-73-992600	T4 - 6"	12
106-73-992700	T5 - 8"	12
106-73-992800	T6 - 10"	12
106-73-992900	T7 - 12"	12
106-73-992950	T8 - 14"	12

## Files - American Pattern

### Mill

Excellent for a wide range of applications such as sharpening, draw filing, lathe work, and general shop use.



Bastard Part No.	Second Cut Part No.	Smooth Part No.	Size	Std. Pkg.
106-73-140500	106-73-141000	106-73-141500	4"	12
106-73-143000	106-73-143500	106-73-144000	6"	12
106-73-145500	106-73-146000	106-73-146500	8"	12
106-73-147500	106-73-148000	106-73-148500	10"	12
106-73-149500	106-73-150000	106-73-150500	12"	6
106-73-151500	106-73-152000	106-73-152500	14"	6

### Flat

Excellent for "hogging" or rapid stock removal. Flat files are double cut on both sides, single cut on the edges and taper toward the point in width.



Bastard Part No.	Second Cut Part No.	Smooth Part No.	Size	Std. Pkg.
106-73-227000	106-73-227500	106-73-228000	4"	12
106-73-229500	106-73-230000	106-73-230500	6"	12
106-73-232000	106-73-232500	106-73-233000	8"	12
106-73-234000	106-73-234500	106-73-235000	10"	12
106-73-236000	106-73-236500	106-73-237000	12"	6
106-73-238000	106-73-238500	106-73-239000	14"	6

### Round

Intended for enlarging and rounding out circular openings or concave surfaces.



Bastard Part No.	Second Cut Part No.	Smooth Part No.	Size	Std. Pkg.
106-73-393000	106-73-393500	106-73-394000	4"	12
106-73-396000	106-73-396500	106-73-397000	6"	12
106-73-398500	106-73-399000	106-73-399500	8"	12
106-73-400500	106-73-401000	106-73-401500	10"	12
106-73-402500	106-73-403000	106-73-403500	12"	6

### Three Square

Excellent for cleaning out corners or for use on cutters, taps and flat surfaces. Three square files are double cut and taper toward the point in width and thickness, and feature the exclusive "wavy tooth" design.



Bastard Part No.	Second Cut Part No.	Smooth Part No.	Size	Std. Pkg.
106-73-516500	106-73-517000	106-73-517500	6"	12
106-73-518000	106-73-518500	106-73-519000	8"	12
106-73-519500	106-73-520000	106-73-520500	10"	12

### Taper Saw

Designed for filing all types of saws with 60° angle teeth.



Single Cut Part No.	Double Cut Part No.	Type	Size	Std. Pkg.
106-73-535500	-	Slim	4"	12
106-73-537000	-	Slim	6"	12
106-73-538000	-	Slim	8"	12
106-73-538500	-	Slim	10"	12
106-73-549500	-	X Slim	6"	12
106-73-550500	-	X Slim	8"	12
106-73-562000	-	Dbl X Slim	6"	12
-	106-73-565000	Dbl X Slim	7"	12
106-73-563000	-	Dbl X Slim	8"	12
106-73-550000	106-73-553500	Extra Slim	7/178	12
106-73-562500	-	Dbl X Slim	7/178	12





## Files - American Pattern (Cont.)

### Half Round Pipeliner

A 14" half round file used for filing weld beads and scale off pipe.



Double Cut Part No.	Description	Std. Pkg.
106-73-756060	14" Half Round File	6

### Regular Half Round

Superb for rounding out holes, corners, and crevices.



Bastard Part No.	Second Cut Part No.	Smooth Part No.	Size	Std. Pkg.
106-73-315000	106-73-315500	106-73-316000	4"	12
106-73-317000	106-73-317500	106-73-318000	6"	12
106-73-319000	106-73-319500	106-73-320000	8"	12
106-73-321000	106-73-321500	106-73-322000	10"	12
106-73-323000	106-73-323500	106-73-324000	12"	6
106-73-325000	106-73-325500	106-73-326000	14"	6

## File Kits

Professional Quality

### 9 Piece 10" General Purpose Set



#### Included:

- Flat Bastard
- Half Round Bastard
- Round Bastard
- Mill Bastard
- Square Bastard
- Flat Smooth
- Slim Taper
- Hoppy Rasp
- File Card
- Roll-up case
- No handles

Part No.	Description	Std. Pkg.
106-72-759250	9 Piece 10" General Purpose Set	1

### 5 Piece 8" General Purpose Set



#### Included:

- Mill Bastard
- Square Bastard
- Round Bastard
- Half Round Bastard
- Flat Multi-Kut®
- Exclusive Maxi-Sharp® Finish

Part No.	Description	Std. Pkg.
106-72-759230	5 Piece General Purpose Set	1

### Black Maxi-Sharp™ Set



For general filing and finishing, one each of the following in a convenient plastic sleeve:

- 8" Mill Bastard
- 8" Flat Multi-Kut®
- 8" Half Round Bastard
- 8" Round Bastard
- 8" Square Bastard
- Black Maxi-Sharp™ Finish
- No Handles

Part No.	Description	Std. Pkg.
106-78-757010	Black Maxi-Sharp™ Set	12

**SIPCO®**  
**Products, Inc.**  
**Safe-T-Rak®**  
**Hard Hat Racks**

- Easily installs and adjusts to fit most hard hats, even the full brim
- 2 models: wall model and seat model

**Wall Model**

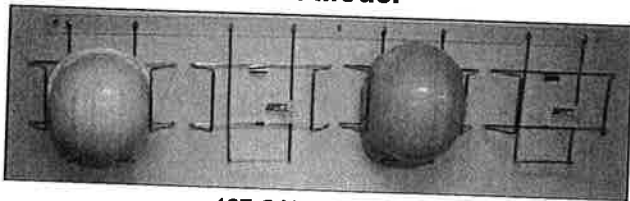

127-SAFE-T-RACK

**Window Mounting Kit for Wall Model**

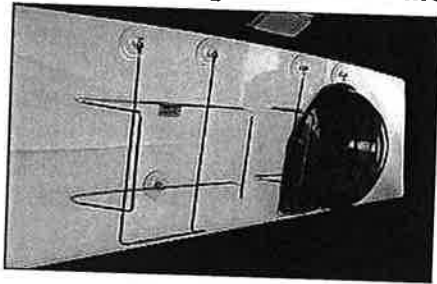

127-STR-3-WMK

**Seat Model**

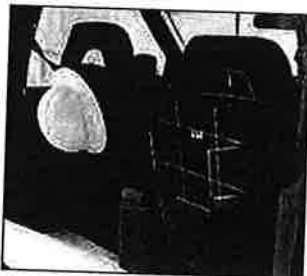

127-SAFE-T-RACK

Part No.	Description	Std. Pkg.
127-SAFE-T-RACK	Wall Model	24
127-SAFE-T-RACK	Seat Model	12
127-STR-3-WMK	Window Model	1 Set

**Swagelok**  
**Snoop®**

**Snoop® Liquid Leak Detector**

- Nontoxic, pure
- Nonflammable
- No residue, dries clean
- No chlorine or halogen additives



Part No.	Description	Std. Pkg.
135-1GAL-SNOOP	Snoop Leak Detector, 1 Gal.	4
135-8OZ-SNOOP	Snoop Leak Detector, 8 Oz.	36
135-MS-RC-SNOOP-8OZ	Snoop Real Cool, 8 Oz. Blue Leak Detector Low Temp	36
135-RC-SNOOP-G	Snoop Real Cool, 1 Gal. Blue Leak Detector Low Temp	4

**SOG**  
**Specialty Knives & Tools**



160-B66-L



160-FSA-8



160-FSA-98



160-S-66-L

Part No.	Description	Std. Pkg.
160-B66-L	SOG PowerAssist Black Multi-Tool with Leather Sheath	1 Ea.
160-FSA-8	SOG Knives Flash II	1 Ea.
160-FSA-98	SOG Knives Flash II - 1/2 Serrated	1 Ea.
160-S-66-L	SOG PowerAssist Multi-Tool with Leather Sheath	1 Ea.



## SPHAG SORB<sup>®</sup>

### Absorbents



183-SS-1



183-SS-2



183-SS-12

Part No.	Description	Absorption	Std. Pkg.
183-SS-1	1.1 Cu. Ft.	4 to 7 Gallons	6 Bag/Box
183-SS-2	2.2 Cu. Ft.	8 to 14 Gallons	30 Bag/Pallet
183-SS-12	18" x 18" Pad	3/4 to 1-1/4 Gallons	15 Pads/Bundle

## 25 Gallon Spill Kit



183-SS-25SRK

### Contents:

- 1 x 25 gallon UN/DOT approved drum
- 1 x SS 3/4 (3/4 cu. ft. loose fill bag)
- 5 x SS 12 (18" x 18" pad)
- 2 x SS 14 (18" x 18" pillow)
- 2 x SS 48 (4" x 48" sock)
- 1 x SS 96 (4" x 96" sock)
- 1 x SS disposal bag (heavy duty)
- 3 x SS dust mask
- 2 x SS glove (pr/Nitrile)
- 1 x SS goggle (pr/safety)
- 2 x SS disposable coveralls
- 1 x PI 1L (plug lt/1L)

**Note:** (Drums may come in blue)

Part No.	Description	Absorption	Std. Pkg.
183-SS-25SRK	3/4 Cu. Ft.	13 to 21 Gallons	18 Kit/Pallet



## Spray Cleaners

### Glass Cleaner



- The most versatile glass cleaner available - cleans glass, windows, mirrors, windshields; enamel surfaces, chrome, tile, porcelain and other hard surfaces
- Dissolves dirt, grease, grit, and grime
- Heavy-duty foam clings to vertical surfaces
- Guaranteed to leave no film
- Contains perfume-grade alcohol for best performance

Part No.	Description	Std. Pkg.
185-50	Sprayway Glass Cleaner	12

## Crazy Clean All Purpose Cleaner



- Multi-purpose cleaner for auto detailers, glass/mirror handlers, industrial maintenance, housekeeping personnel, or sign/display tradesmen
- Clinging foam cleans and deodorizes
- Removes hand prints, scuff and crayon marks, grease spots, soot stains, and smoke film
- Produces sparkling results when used on hard surfaces; on window sills or venetian blinds

Part No.	Description	Std. Pkg.
185-31	Sprayway Crazy Clean All Purpose Cleaner	12

# SUPERIOR

*Abrasives*

## Mounted Flap Wheels



Part No.	Size	Grit	Std. Pkg.
136-10106	1" x 1"	120	10
136-10127	2" x 1"	120	10
136-10151	3" x 1"	120	10

## SUPERIOR *Abrasives*

### Shop Rolls



- Flexible "J" wt., resin cloth
- Fast cutting action
- Easily used for hand applications
- Ideal for lathe work
- Top of the line quality

Part No.	Size	Grit	Std. Pkg.	
136-12106	1" x 50 Yds.	50J	1	
136-12107		60J	1	
136-12108		80J	1	
136-12109		100J	1	
136-12110		120J	1	
136-12111		150J	1	
136-12112		180J	1	
136-12113		220J	1	
136-12114		240J	1	
136-12115		320J	1	
136-12116		400J	1	
136-12117		500J	1	
136-12118		1-1/2" x 50 Yds.	50J	1
136-12119			60J	1
136-12120			80J	1
136-12121	100J		1	
136-12122	120J		1	
136-12123	150J		1	
136-12124	180J		1	
136-12125	220J		1	
136-12126	240J		1	
136-12127	320J		1	
136-12128	400J		1	
136-12129	500J		1	
136-12130	2" x 50 Yds.		50J	1
136-12131			60J	1
136-12132			80J	1
136-12133		100J	1	
136-12134		120J	1	
136-12135		150J	1	
136-12136		180J	1	
136-12137		220J	1	
136-12138		240J	1	
136-12139		320J	1	
136-12140		400J	1	
136-12141		500J	1	

## SWANSON

### Levels

#### Top Read Aluminum Levels

Constructed with high-grade aluminum frames and shock-resistant end caps. Acrylic windows protect the vials from breakage.



Part No.	Description	Std. Pkg.
095-TRL240	24" Top Read Level	3
095-TRL480	48" Top Read Level	3

#### Box Beam Levels

The Super Shock™ feature rubberized end caps protect against shock when dropped or bumped. Aluminum frame for maximum durability, impact-resistant solid block vials, and comfort grips for easy of handling.



Part No.	Description	Std. Pkg.
095-BBL240	24" Box Beam Level	3
095-BBL480	48" Box Beam Level	3

#### Magnetic I-Box™ Levels

Same features as the Box Beam Levels.



Part No.	Description	Std. Pkg.
095-IBL24M	24" Magnetic I-Box™ Levels	3
095-IBL48M	48" Magnetic I-Box™ Levels	3

#### Magnetic Torpedo Level

High impact ABS frame with durable aluminum rails. Top read feature.



Part No.	Description	Std. Pkg.
095-TL001M	9" Magnetic Torpedo Level	10

# SWANSON

## Levels (Cont.)

### Magnetic Torpedo Level

Impact-resistant body with rubber ends. Top read feature. Large acrylic high-visibility vials.

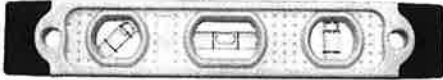

Part No.	Description	Std. Pkg.
095-TL021M	9" Magnetic Torpedo Level	10

### Lil' Savage® Magnetic Torpedo Level

Swanson's Lil' Savage® Magnetic Torpedo Level is a pocket-sized "do-it-all" level designed for every tradesman and carpenter.



Part No.	Description	Std. Pkg.
095-TL041M	Lil' Savage® Magnetic Torpedo Level	10

### Savage® Magnetic Torpedo Level

Swanson's Savage® Magnetic Torpedo Level is a "do-it-all" level designed for every tradesman and carpenter.



Part No.	Description	Std. Pkg.
095-TL043M	Savage® Magnetic Torpedo Level	10

### Aluminum Line Level

Heavy-duty aluminum, snag-free open hooks allow free sliding level.



Part No.	Description	Std. Pkg.
095-LLA001	4" Aluminum Line Level	12

## Builder Squares

High-grade aluminum alloy. 3/16" thick aluminum alloy. All aluminum squares have permanently impressed gradations.

Part No.	Description	Std. Pkg.
095-TA127	16" x 24" Heavy-Duty Rafter Square	6

High-grade tempered steel with thermally fused powder paint finish. Reverse-reading scale.

Part No.	Description	Std. Pkg.
095-TS157	16" x 24" Steel Carpenter Square	6

## Combination Squares

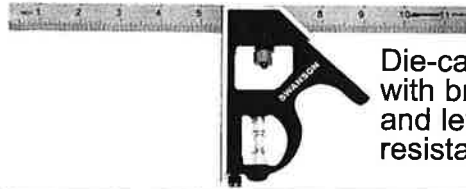

Die-cast zinc body with brass scriber and lever, impact resistant acrylic vial.

Part No.	Description	Std. Pkg.
095-TC132	12" Combination Square	6

Brass bolt spring-loaded blade assures firm, accurate settings. Stainless steel blades with black etchings, includes brass hardware, scriber and level.

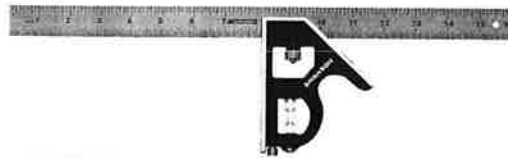

Part No.	Description	Std. Pkg.
095-TC134	16" Pro Combination Square	6

## Utility Square

Face graduations in 8ths and 12ths; back in 8ths and 6ths. High-grade steel, thermally fused powder paint finish. Permanently impressed gradations.

Part No.	Description	Std. Pkg.
095-TS153	8" x 12" Steel Utility Square	12

## SWANSON

### Straight Edge

1-1/4" wide, high-grade aluminum alloy with non-glare finish. Lightweight and strong, with black graduations.

Part No.	Description	Std. Pkg.
095-AE141	36" Yellow Straight Edge Yardstick	10

### Magnetic Angle Finder



Determine any angle, pipe pitches quickly, attach to straight edge for fast layout.

Part No.	Description	Std. Pkg.
095-AF006M	Magnetic Angle Finder	1

### MAG<sup>®</sup> Square



Magnetic surface holds on edge and face of material. 3/16" thick aluminum alloy.

Part No.	Description	Std. Pkg.
095-S0114	10" Magnetic Aluminum	5

## Syraco<sup>™</sup> PRODUCTS

### Gate Faucet

- Excellent for dispensing heavy oils, light grease, molasses, honey, cream and other non-flammable viscous fluids
- Machined and lapped brass face plate for smooth operation and perfect seal
- Durable cast iron body



Part No.	NPT Inlet Size	Weight Per Pkg.	Std. Pkg.
180-V0071075	3/4"	18 Lbs.	12
180-V0072100	1"	12 Lbs.	6
180-V0073125	1-1/4"	14.5 Lbs.	6
180-V0074150	1-1/2"	17.5 Lbs.	6
180-V0075200	2"	19 Lbs.	6
180-V0039300	3"	27 Lbs.	4
180-V0040400	4"	15.5 Lbs.	1



## TENNESSEE Hickory Handles

### Axe & Pick Handles

### Seasoned Hickory & Ash Handles



013-1136-8



013-1536-8



013-3136-8

Part No.	Description	Std. Pkg.
013-1136-8	36" Single Bit Axe Handle	12
013-1536-8	36" Double Bit Axe Handle	12
013-3136-8	36" Pick/Mattock Handle, #7 Eye	12

### Sledge Hammer Handles



Part No.	Description	Std. Pkg.
013-2124-8	24" Sledge Hammer Handle	12
013-2130-8	30" Sledge Hammer Handle	12
013-2132-8	32" Sledge Hammer Handle	12
013-2136-8	36" Sledge Hammer Handle	12
013-2636-8	36" X-Heavy Sledge Handle	12

### Nail or Claw Hammer Handles



Part No.	Description	Std. Pkg.
013-7114-8	14" Nail/Claw Hickory Handle	12
013-7116-8	16" Nail/Claw Hammer Handle	12



## TENNESSEE Hickory Handles

### Machinist's Ball Peen Hammer Handles



Part No.	Description	Std. Pkg.
013-7212-8	12" Machinist/Ball Peen Handle	12
013-7214-8	14" Machinist/Ball Peen Handle	12
013-7216-8	16" Machinist/Ball Peen Handle	12
013-7218-8	18" Machinist/Ball Peen Handle	12

### Engineer's/Blacksmith's Hammer Handle

For 1-1/2 to 6 Lb. Hammers



Part No.	Description	Std. Pkg.
013-7316-8	16" Engineer's Hammer Handle	12
013-7318-8	18" Engineer's Hammer Handle	12
013-7314-8	14" Heavy Blacksmith Handle	12

### For 2 to 4 Lb. Hammers



Part No.	Description	Std. Pkg.
013-7414-8	14" Blacksmith Hammer Handle	12
013-7416-8	16" Blacksmith Hammer Handle	12
013-7418-8	18" Blacksmith Hammer Handle	12

### Drill Hammer

For 2 to 4 Lb. Hammers



Part No.	Description	Std. Pkg.
013-7712-8	12" Drill Hammer Handle	12

### Rig Builders Hatchet Handle



Part No.	Description	Std. Pkg.
013-10418-8	18" Rig Builders Hatchet Handle	12

### Shovel Handles



013-APS-4



013-FS-40



013-2SH30R

Part No.	Description	Std. Pkg.
013-APS-4	48" Hickory Straight Hollowback Handle	12
013-FS-40	48" Shovel Handle, Closed/Hollow Back	12
013-2SH30R	30" Hickory Dee Handle Hollowback Handle	12

### Light Rake Hoe Cultivator



Part No.	Description	Std. Pkg.
013-H50	60" Rake Handle	12

### Hoe Handles

#### Eye Hoe Garden Mattock-Scovil



Part No.	Description	Std. Pkg.
013-N50-8	60" x 1-3/4" Eye Hoe Handle	12

### Light Hoe & Scraper



Part No.	Description	Std. Pkg.
013-150	60" Replacement Hoe Handle	12



## TENNESSEE Hickory Handles

### Post Hole Diggers

#### Round and Square

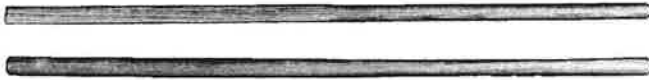

Part No.	Description	Std. Pkg.
013-2RD-4	4' Round Post Hole Digger Handle	12
013-2SD-4	4' Square Post Hole Digger Handle	12

### Wedges

Part No.	Description	Std. Pkg.
013-21WP	Wedge Pack for Sledge	12
013-21WW	Wedge Pack for Sledge	12
013-3SW	#3 Steel Hammer Wedges	12
013-4SW	#4 Steel Hammer Wedges	12
013-71WP	Hardwood Hammer Wedge Pack	12
013-71WW	Hardwood Hammer Wedge Pack	12



### Duct Tape

#### Polycoated Cloth Tape



#### Utility Grade

- Thickness-mils: 7.5
- Adhesion-oz/in: 40
- Tensile-lbs/in: 18
- Elongation %: 18%

#### Industrial Grade

- Thickness-mils: 9
- Adhesion-oz/in: 40
- Tensile-lbs/in: 24
- Elongation %: 16%

#### Professional Grade

- Thickness-mils: 12
- Adhesion-oz/in: 65
- Tensile-lbs/in: 24
- Elongation %: 18%

Part No.	Description	Std. Pkg.
074-64613	7.5 Mil, Utility Grade Duct Tape	24
074-64662	9 Mil, Industrial Grade Duct Tape	24
074-64663	12 Mil, Professional Grade Duct Tape	24







# Oilfield Supplies



## TOUGHBUILT™

### Compact Bolt Cutters

The Toughbuilt™ compact bolt cutters set a new standard of innovation. Their patent-pending folding mechanism, for the first time ever, allows them to fold nearly in half without compromising an ounce of strength. They easily fit into a tool box or tool bag unlike any other bolt cutter. Their extra wide rubber-coated handles evenly and comfortably distribute the pressure on the hands, minimizing the effort it takes to cut a hardened steel bolt. Constructed of the highest-grade steel, these bolt cutters withstand the harshest working conditions.

- Designed to fit your toolbox
- Innovative folding mechanism
- Powder coated finish
- CR-MO steel
- Hardened cutting tip
- Adjustable bolts
- Extra wide rubber handles



198-F140



198-F180



198-F240

Part No.	Description	Std. Pkg.
198-F140	14" Compact Bolt Cutter	6
198-F180	18" Compact Bolt Cutter	6
198-F240	24" Compact Bolt Cutter	3



## Advanced ShopMax Wipers

### 450 Centerfeed Dry Wipe Bucket Dispenser

- Reusable portable dry wipe bucket dispensing system
- Removable lid for easy on-off quick access
- Pop top is resealable, angled and connected to water channels for maximum protection
- Handle designed for easy portability and added convenience
- Dispensing disk designed for single towel dispensing to reduce pilferage and lower cost-in-use
- Plastic container is durable to protect against dry or wet chemicals
- Stackable packaging design allows for more efficient packing and storage



174-192150

### 450 Centerfeed Refill

- Best all purpose with cloth like softness
- Absorbs large spills and leaks
- Janitorial maintenance wiping
- Patient hygiene
- Line wiping and cleaning
- Absorbs oil and water
- Works on grease and grime
- Industrial cleaning and maintenance
- Hands and face



174-192151

### 450 Wiper Roll

- Strong enough to power through oil, grease and solvents
- Ideal everyday solution for general cleanup and spills
- Thick, cloth-like construction is highly absorbent and low linting
- Convenient towel for shop, auto and home
- Multipurpose disposable towels are an excellent replacement for cloth rags



174-192160A

Part No.	Description	Std. Pkg.
174-192150	Dry Wipe Bucket Dispenser	2/Cs.
174-192151	Centerfeed Refill	2/Cs.
174-192160A	Wiper Roll	30/Cs.



## General Purpose Black Oxide Drill Sets

### T13B Series

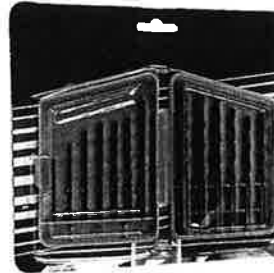

• 1/16" - 1/4" by 64ths

084-099710

### T17B Series



• 1/16" - 1/2" by 32nds

084-099802

### T18B Series

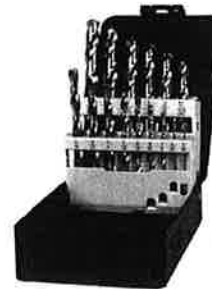

• 1/16" - 1/2" by 32nds

084-099808

Part No.	Description	Std. Pkg.
084-099710	13 Piece Drill Set	1
084-099802	29 Piece Drill Set	1
084-099808	15 Piece Drill Set	1



### General Purpose Black Oxide Drill Sets (Cont.)

#### T180B Series

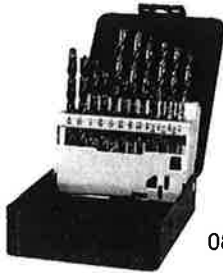

• 1/16" - 3/8" by 64ths

084-099835

Part No.	Description	Std. Pkg.
084-099835	21 Piece Drill Set	1

### Tap & Die Sets

#### T513 Series

- 17 plug taps, 16 hex dies (1" O.D.), molded case
- 1/4-20 NC, 5/16-18 NC, 3/8-16 NC, 7/16-14 NC, 1/2-13 NC, 4-40 NC, 6-32 NC, 8-32 NC, 10-24 NC, 12-24 NC, 1/4-28 NF, 5/16-24 NF, 3/8-24 NF, 7/16-20 NF, 1/2-20 NF, 10-32 NF, 4-36 NS

#### Accessories included in this set:

- 1/8-27 NPT hex dies
- 1/8-27 NPT pipe tap
- TRD47 hex die stock
- JT20 tap wrench
- JT40 tap wrench



084-069963

Part No.	Description	Std. Pkg.
084-069963	38 Piece Tap and Die Set	1



### Sledge Hammers Hickory Handle



Part No.	Ames Part No.	Description	Std. Pkg.
031-MD-6H	1197400	6 Lb. Sledge Hammer, 36" Hickory Handle	4
031-MD-8H	1197900	8 Lb. Sledge Hammer, 36" Hickory Handle	4
031-MD-10H	1199100	10 Lb. Sledge Hammer, 36" Hickory Handle	4
031-MD-12H	1199400	12 Lb. Sledge Hammer, 36" Hickory Handle	2
031-MD-16H	1199700	16 Lb. Sledge Hammer, 36" Hickory Handle	2
031-MD-20H	1199900	20 Lb. Sledge Hammer, 36" Hickory Handle	2

### Fiberglass Handle



Part No.	Ames Part No.	Description	Std. Pkg.
031-MD-6F	1197600	6 Lb. Sledge Hammer, 36" Fiberglass Handle	4
031-MD-8F	1198800	8 Lb. Sledge Hammer, 36" Fiberglass Handle	4
031-MD-10F	1199300	10 Lb. Sledge Hammer, 36" Fiberglass Handle	4
031-MD-12F	1199600	12 Lb. Sledge Hammer, 36" Fiberglass Handle	2
031-MD-16F	1199800	16 Lb. Sledge Hammer, 36" Fiberglass Handle	2

### Engineer's Hammers Hickory Handle



Part No.	Ames Part No.	Description	Std. Pkg.
031-MD-2H	1196200	2 Lb. Engineers Hammer, 16" Hickory Handle	4
031-MD-2.5H	1105300	2.5 Lb. Engineers Hammer, 16" Hickory Handle	4
031-MD-3H	1196300	3 Lb. Engineers Hammer, 16" Hickory Handle	4
031-MD-4H	1196900	4 Lb. Engineers Hammer, 16" Hickory Handle	4



## Engineer's Hammers (Cont.)

### Fiberglass Handle



Part No.	Ames Part No.	Description	Std. Pkg.
031-MD-2F	—	2 Lb. Engineers Hammer, 16" Fiberglass Handle	4
031-MD-2.5F	—	2.5 Lb. Engineers Hammer, 16" Fiberglass Handle	4
031-MD-3F	1196800	3 Lb. Engineers Hammer, 16" Fiberglass Handle	4
031-MD-4F	1197000	4 Lb. Engineers Hammer, 16" Fiberglass Handle	4

### Cross Peen Hammers

#### Hickory Handle



Part No.	Ames Part No.	Description	Std. Pkg.
031-CRP-2H	1196000	2 Lb. Cross Peen Hammer, 16" Hickory Handle	4
031-CRP-3H	1196700	3 Lb. Cross Peen Hammer, 16" Hickory Handle	4
031-CRP-4H	1197300	4 Lb. Cross Peen Hammer, 16" Hickory Handle	4

#### Fiberglass Handle



Part No.	Ames Part No.	Description	Std. Pkg.
031-CRP-3F	1196600	3 Lb. Cross Peen Hammer, 16" Fiberglass Handle	4
031-CRP-4F	—	4 Lb. Cross Peen Hammer, 16" Fiberglass Handle	4

## Drilling Hammers

### Hickory Handle



Part No.	Ames Part No.	Description	Std. Pkg.
031-DHT-2H	1196100	2 Lb. Drilling Hammer, 10" Hickory Handle	4
031-DHT-3H	1196400	3 Lb. Drilling Hammer, 10" Hickory Handle	4
031-DHT-4H	1197100	4 Lb. Drilling Hammer, 10" Hickory Handle	4

### Fiberglass Handle



Part No.	Ames Part No.	Description	Std. Pkg.
031-DHT-3F	1196500	3 Lb. Drilling Hammer, 10" Fiberglass Handle	4
031-DHT-4F	—	4 Lb. Drilling Hammer, 10" Fiberglass Handle	4

## Camp Axes

### Hickory Handle



Part No.	Ames Part No.	Description	Std. Pkg.
031-HC-1-1/4H	1188000	1-1/4 Lbs. Camp Axe, 14" Hickory Handle	6

### Fiberglass Handle



Part No.	Ames Part No.	Description	Std. Pkg.
031-HC-1-1/4F	—	1-1/4 Lbs. Camp Axe, 14" Fiberglass Handle	6



# Oilfield Supplies



## Michigan Axes - Hickory Handle

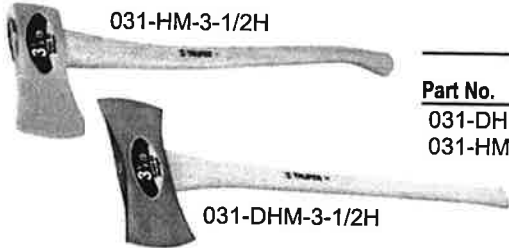

Part No.	Ames Part No.	Description	Std. Pkg.
031-DHM-3-1/2H	1188600	3.5 Lb. Double Bit Michigan Axe, Hickory Handle	4
031-HM-3-1/2H	1188200	3.5 Lb. Single Bit Michigan Axe, Hickory Handle	4

## Splitting Mauls & Wedges

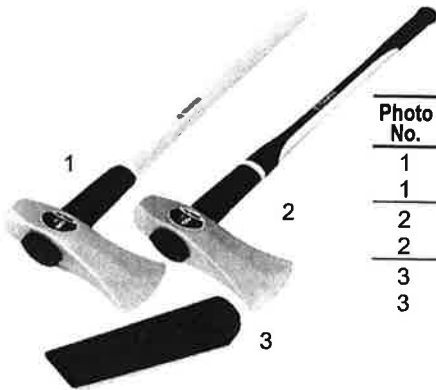
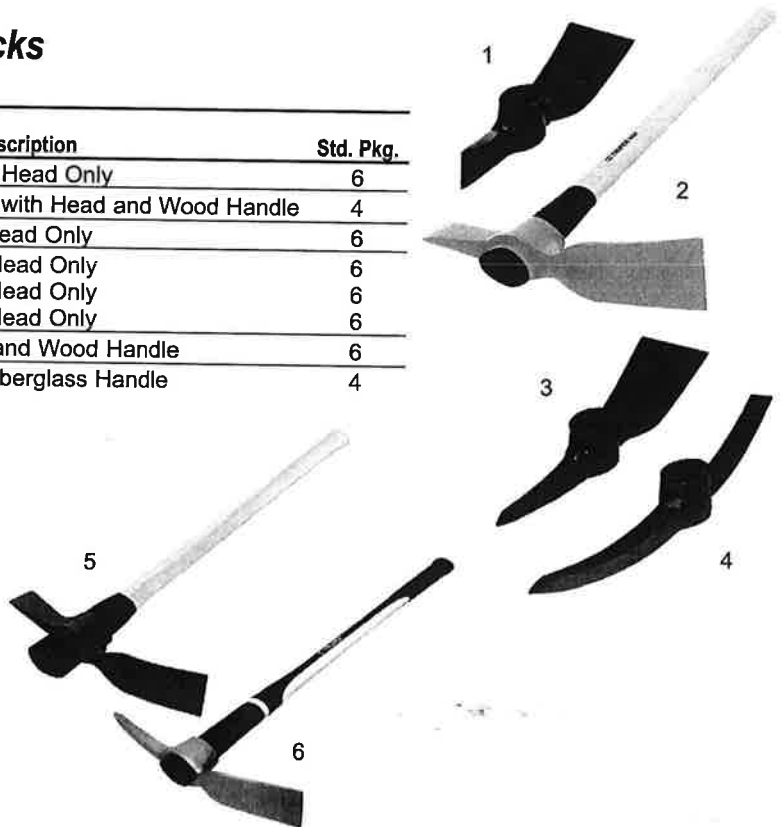

Photo No.	Part No.	Ames Part No.	Description	Std. Pkg.
1	031-TJ-6H	1189400	6 Lb. Splitting Maul, Sledge Eye, Hickory Handle	4
1	031-TJ-8H	1189800	8 Lb. Splitting Maul, Sledge Eye, Hickory Handle	4
2	031-TJ-6F	—	6 Lb. Splitting Maul, 36" Fiberglass Handle	4
2	031-TJ-8F	1189800	8 Lb. Splitting Maul, 36" Fiberglass Handle	4
3	031-WG-3	1131900	3 Lb. Splitting Wedge	10
3	031-WG-4	1132200	4 Lb. Splitting Wedge	10

## Picks & Mattocks

Photo No.	Part No.	Ames Part No.	Description	Std. Pkg.
1	031-TH-5	1135400	5 Lb. Cutter Mattock, Head Only	6
2	031-TH-5M	1195300	5 Lb. Cutter Mattock, with Head and Wood Handle	4
3	031-TP-5	1136500	5 Lb. Pick Mattock, Head Only	6
4	031-ZP-5	1137800	5 Lb. Railroad Pick, Head Only	6
4	031-ZP-6	1138700	6 Lb. Railroad Pick, Head Only	6
4	031-ZP-7	1139600	7 Lb. Railroad Pick, Head Only	6
5	031-TP-5M	1195000	5 Lb. Mattock, Head and Wood Handle	6
6	031-TP-5F	1195100	5 Lb. Pick Mattock, Fiberglass Handle	4



# Oilfield Supplies

291



## Bars

### 1. TB Series



### 3. WPB Series



### 2. BAP Series



### 4. PPB Series



Photo No.	Part No.	Ames Part No.	Description	Std. Pkg.
1	031-TB-12	1168000	Tamping Bar, 48", 12 Lb.	3
1	031-TB-175	1160000	Tamping Bar, 69", 16 Lb.	3
2	031-BAP-150	1174800	San Angelo Bar, 1" x 60" Hexagonal, 14 Lb.	3
2	031-BAP-175	1160300	San Angelo Bar, 1" x 72" Hexagonal, 16 Lb.	3
3	031-WPB-51	1162700	Wedge Point Bar, 51", 12 Lb.	3
3	031-WPB-60	1160200	Wedge Point Bar, 60", 18 Lb.	3
4	031-PPB-48	1161400	Pinch Point Bar, 48", 10 Lb.	3
4	031-PPB-51	1161600	Pinch Point Bar, 51", 12 Lb.	3
4	031-PPB-60	1160100	Pinch Point Bar, 60", 18 Lb.	3
4	031-PPB-64	1162500	Pinch Point Bar, 64", 22 Lb.	3

### 5. BU Series



Photo No.	Part No.	Ames Part No.	Description	Std. Pkg.
5	031-BU-30	1169400	Wrecking Bar, 1/2" x 12" Hexagonal, 1-1/4" Lb.	6
5	031-BU-45	1169800	Wrecking Bar, 5/8" x 18" Hexagonal, 2-1/4" Lb.	6
5	031-BU-60	1170500	Wrecking Bar, 3/4" x 24" Hexagonal, 3-1/4" Lb.	6
5	031-BU-75	1171000	Wrecking Bar, 3/4" x 30" Hexagonal, 4-1/4" Lb.	6
5	031-BU-90	1171600	Wrecking Bar, 3/4" x 36" Hexagonal, 5-1/4" Lb.	6
5	031-BU-105	1172500	Wrecking Bar, 7/8" x 42" Hexagonal, 8 Lb.	6
5	031-BU-120	1173000	Wrecking Bar, 1" x 48" Hexagonal, 13 Lb.	6

### 6. BUX Series



### Utility Bar



Photo No.	Part No.	Stanley Part No.	Description	Std. Pkg.
6	031-BUX-35	55-101	14" Wrecking Bar, 1.94 Lb.	6
6	031-BUX-60	55-102	24" Wrecking Bar, 5.18 Lb.	6

Part No.	Ames Part No.	Description	Std. Pkg.
031-BA-UT-15	1167000	Utility Bar, 15", 2 Lb.	6

# Oilfield Supplies



## Shovels

### Professional Grade



Photo No.	Part No.	Ames Part No.	Description	Handle Size	Std. Pkg.
1	031-PRL-RBA	1309800	Round Point Shovel, Long Handle	48"	6
1	031-PRL-RBA-CB	1303900	Round Point Shovel, Closed Back, Long Handle	48"	6
1	031-PRY-RBA	1309600	Round Point Shovel, D-Handle	30"	6
2	031-PRL-F	1558300	Round Point Shovel, Long Handle-Fiberglass	48"	6
3	031-PCL-F	1550500	Square Point Shovel, Fiberglass Handle, 9" Grip	48"	6
3	031-PCL-RBA	1309500	Square Point Shovel, Long Handle	48"	6
3	031-PCL-RBA-CB	1303500	Square Point Shovel, Closed Back, Long Handle	48"	6
3	031-PCY-RBA	1309300	Square Point Shovel, D-Handle	30"	6
4	031-PEP-16F	1558800	16" Drain Spade, Fiberglass D-Handle	29"	6
4	031-PEP-16-RBA	1577000	16" Drain Spade, D-Handle	32"	6
5	031-PALY-12	1681200	Aluminum Scoop #12, D-Handle	27"	6
5	031-PALY-12M	1650300	Aluminum Scoop #12, Steel D-Handle	27"	6
6	031-PST-L	1632400	Street Shovel, #2 Blade, Long Handle	48"	6

### Medium Duty Grade

### Utility Grade

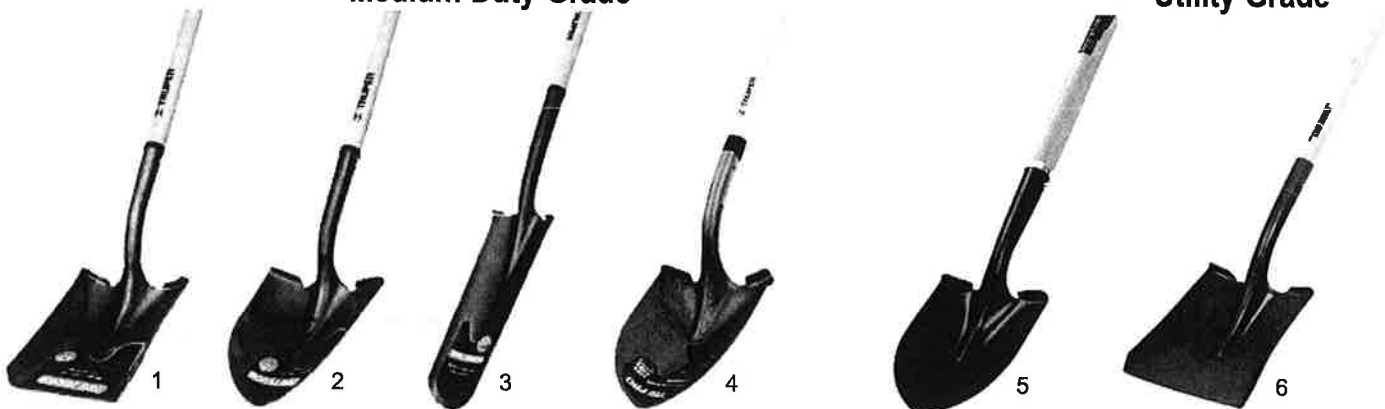

Photo No.	Part No.	Ames Part No.	Description	Handle Size	Std. Pkg.
1	031-PCL-ES	1551300	Square Point Shovel, Long Handle	48"	6
2	031-PRL-E	1574000	Round Point Shovel, Long Handle, 6" Grip	48"	6
3	031-PEP-16E	1552100	16" Drain Spade, D-Handle	30"	6
4	031-PRL-ES	1551100	Round Point Shovel, Long Handle, w/o Grip	48"	6
5	031-PRL-PE	1554300	Round Point Shovel, Long Handle	45"	6
6	031-PCL-FP	1348300	Square Point Shovel, Long Handle, Fiberglass	47"	6
6	031-PCL-PE	1554500	Square Point Shovel, Long Handle	45"	6



## Rakes & Hoes

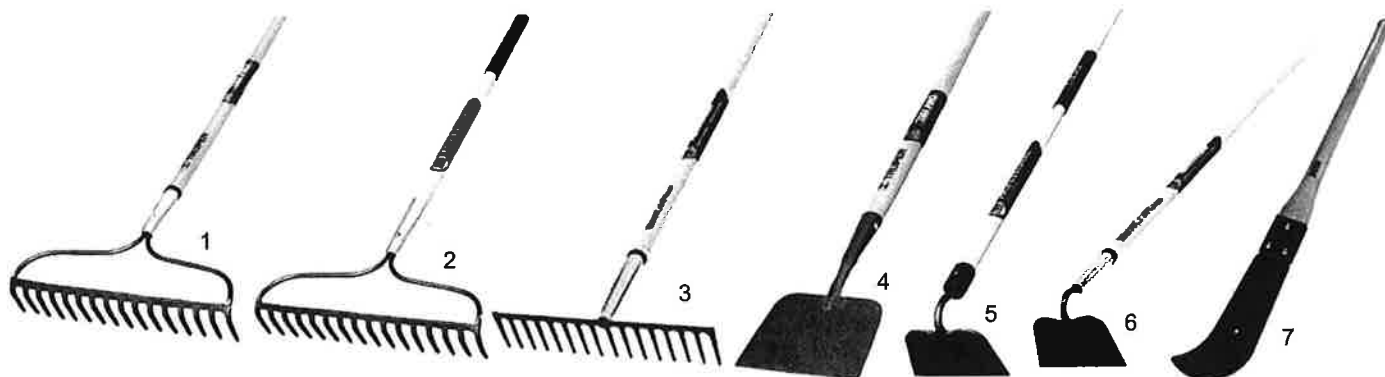

Photo No.	Part No.	Ames Part No.	Union Tool No.	Description	Handle Size	Std. Pkg.
1	031-R-16AM-E	1886600	—	Welded Bow Rake, 16 Tines, 6" Grip, Wood Handle	54"	6
1	031-R-16AM-X	1886300	63-141	16 Tines, Forged Bow Rake	60"	6
2	031-R-16AM-FX	1876700	—	16 Tines, Forged Bow Rake, Fiberglass Handle	60"	6
3	031-R-16MX	1887200	63-111	16 Tines, Level Rake	60"	6
4	031-SCR-FX	1646300	78-202	Forged Sidewalk & Ice Scraper, 7" x 6"	48"	6
5	031-ATJ-X	1849000	65-102	6" Forged Head Garden Hoe	60"	6
6	031-ATJ-F	—	—	6" Forged Head Garden Hoe, Fiberglass Handle	60"	6
7	031-DBB-16	2316600	—	16" Ditch Bank Blade, Hickory Handle	40"	3

## Sledge Handle, Wheel Barrows, Tire & Hole Diggers

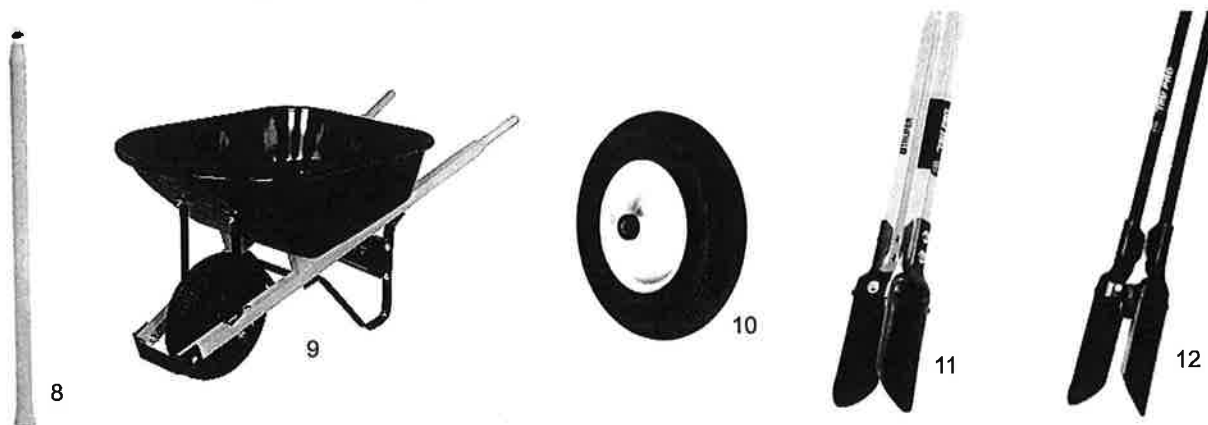

Photo No.	Part No.	Ames Part No.	Union Tool No.	Description	Handle Size	Std. Pkg.
8	031-MG-MD-6/16F	2013100	—	36" Fiberglass Handle for Sledge	36"	6
9	031-6S-HK	M6T22KB	77-323	Heavy Duty Wheel Barrow, 6 Cu. Ft., 16" Tire	—	1
9	031-TR6	R6	—	Heavy Duty Wheel Barrow, 6 Cu. Ft., 16" Tire	1-3/4"	1
10	031-FFT	FFTCC	—	16" Flat Free Tire	—	1
11	031-CA-38E	1706100	78-005	Heavy Duty Post Hole Digger, Wood Handles	48"	2
12	031-CA-38M	—	78-007	Heavy Duty Post Hole Digger, Steel Handles	48"	2



## Cable Hoist/Puller

- Solid steel construction
- Dual-ratchet drive design



071-TT2-4W



071-TT2-7.2C

Part No.	Capacities	Reach
071-TT2-4W	2000 Lbs. Lift/4000 Lbs. Pull Web-Strap Hoist/Puller	4 Ft. Double Line
071-TT2-7.5C	2000 Lbs. Lift/4000 Lbs. Pull Cable Hoist/Puller	7-1/2 Ft. Double Line



## LED Flexible Spring Claw

- 25-1/4 in. long
- Convenient side switch turns on/off bright LED light as needed
- Press plunger and jaws open wide/release plunger and jaws clamp shut
- Tightly wound spring snakes into tight areas to retrieve dropped objects

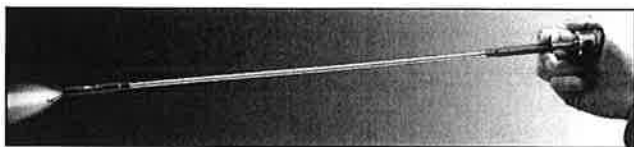

Part No.	Description	Std. Pkg.
201-16LT	Lighted Flexible Spring Claw	Ea.

## Inspection Mirrors

- 7/8" mirror diam.
- Overall length 7-1/2" 201-A-2



- 1" x 2" mirror
- Overall length 8-1/2" 201-B-2



- 2-1/4" mirror diam.
- Overall length 10", extends to 14" 201-C-2

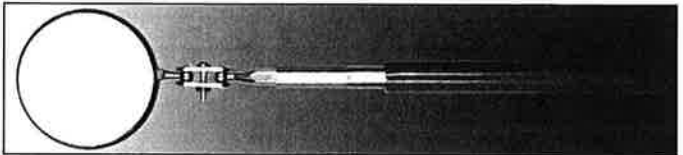

- 1-1/4" mirror diam.
- Overall length 8" 201-E-2

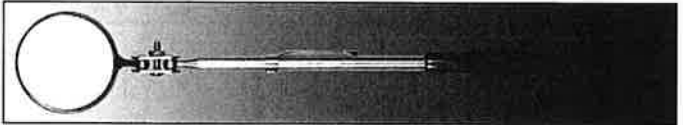

- 2-1/8" x 3-1/2" mirror 201-K-2
- Overall length 11-1/4", extends to 15-1/4"

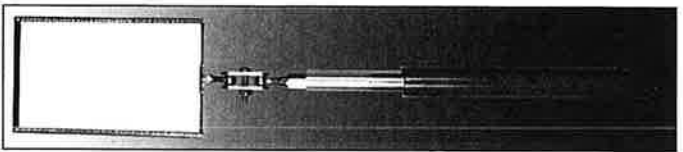

- 3-1/4" mirror diam.
- Overall length 11", extends to 15" 201-S-2

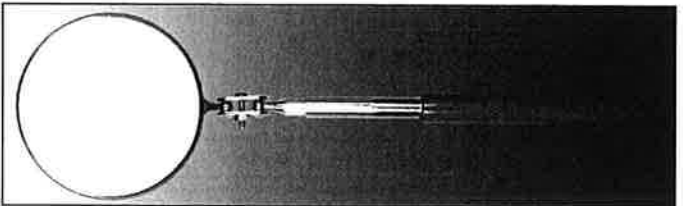

Part No.	Description	Std. Pkg.
201-A-2	7/8" Round Inspection Mirror 7-1/5"	Ea.
201-B-2	1" x 2" Oval Inspection Mirror 8-1/2"	Ea.
201-C-2	2-1/4" Round Inspection Mirror 10-14"	Ea.
201-E-2	1-1/4" Round Inspection Pocket Mirror 8"	Ea.
201-K-2	2-1/8" x 3-1/2" Rectangular Inspection Mirror 11-1/4" to 15-1/4"	Ea.
201-S-2	3-1/4" Round Inspection Mirror 11-15"	Ea.



## Telescoping Inspection Mirrors

- 1-1/4" mirror diam.
- Extends to 18-1/2", closes down to 1/2"

201-E-2T

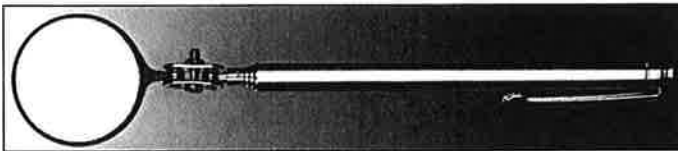

- Stainless steel telescoping handle is strong, long and lightweight
- 2-1/4" mirror diam.
- Telescopes from 6-1/2" to 36-3/8"

201-HT-C2



- 1-3/8" mirror
- Stainless steel handle
- Telescopes from 6-3/4" to 35-1/2"

201-HTC-2LT

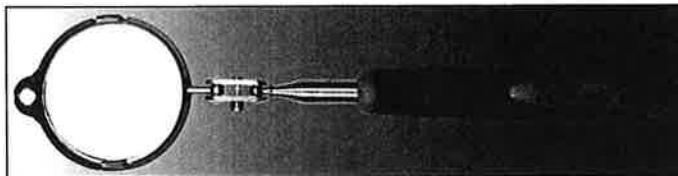

Part No.	Description	Std. Pkg.
201-E-2T	1-1/4" Round Telescopic Pocket Mirror, 4-1/2" to 18-1/2"	Ea.
201-HT-C2	2-1/4" Telescopic Inspection Mirror	Ea.
201-HTC-2LT	2-3/8" Round Lighted Mirror 6-3/4" to 35-1/2"	Ea.

## Magnetic Pick-Up Tool

- Telescopes from 7-1/8" to 30-1/4"
- Head shields the sides of the magnet from attaching to unwanted metal surfaces
- Stainless steel handle is long, strong and lightweight
- Comfortable textured cushion pistol grip keeps handle secure even in wet or oily hands

201-GM-2



Part No.	Description	Std. Pkg.
201-GM-2	Telescoping Magnetic 8-1/4" to 30-1/4"	Ea.

## Hook & Pick

- 6-5/16" long
- Made of high carbon polished steel
- Permanently attached to a hex shaped aluminum handle

201-PH-4

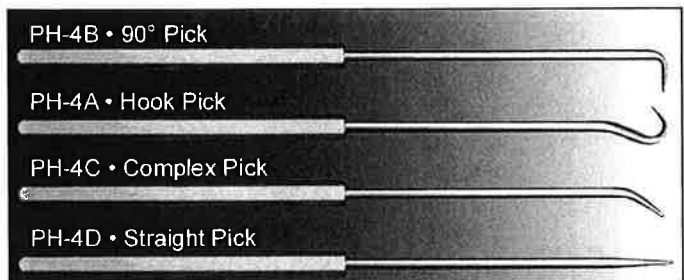

Part No.	Description	Std. Pkg.
201-PH-4	4 Piece Hook & Pick Set	Ea.



## Derrick Complete Tapes



Derrick tapes are strong and durable with a corrosion resistant frame. The frames have safety yellow handle and longer crank arm to speed retraction. Derrick tapes are available with English/Decimal or Metric blades.

Part No.	Description	Std. Pkg.
204-59625	1/4" x 100' Derrick Tape	1
204-59725	1/4" x 100' Derrick Refill	1

## Oil Gauge - Plated Complete Tapes



Plated Oil Gauges are for use with corrosive liquids. Blades are available in: English, English/Metric and Decimal. Inage or outage.

Part No.	Description	Std. Pkg.
204-58813	1/2" x 25' Plated Inage Gauging Tape	1
204-58815	1/2" x 33' Plated Inage Gauging Tape	1
204-58819	1/2" x 50' Plated Inage Gauging Tape	1
204-58849	1/2" x 50'/15m Plated Inage Gauging Tape	1
204-58851	1/2" x 66'/20m Plated Inage Gauging Tape	1
204-58855	1/2" x 100'/30m Plated Inage Gauging Tape	1
204-58913	1/2" x 25' Plated Inage Refill	1
204-58915	1/2" x 33' Plated Inage Refill	1
204-58919	1/2" x 50' Plated Inage Refill	1
204-58949	1/2" x 50'/15m Plated Inage Refill	1
204-58951	1/2" x 66'/20m Plated Inage Refill	1
204-58955	1/2" x 100'/30m Plated Inage Refill	1

## Oil Gauge - Double Duty Complete Tapes



Double Duty Oil gauges are for use with dark and light liquids. Blades are available in: English and English/Metric. Inage or Outage.

Part No.	Description	Std. Pkg.
204-58814	1/2" x 25' Double Duty Inage Gauging Tape	1
204-58816	1/2" x 33' Double Duty Inage Gauging Tape	1
204-58820	1/2" x 50' Double Duty Inage Gauging Tape	1
204-58850	1/2" x 50'/15m Double Duty Inage Gauging Tape	1
204-58822	1/2" x 66' Double Duty Inage Gauging Tape	1
204-58853	1/2" x 66'/20m Double Duty Inage Gauging Tape	1
204-58824	1/2" x 75' Double Duty Inage Gauging Tape	1
204-58854	1/2" x 75'/23m Double Duty Inage Gauging Tape	1
204-58826	1/2" x 100' Double Duty Inage Gauging Tape	1
204-59055	1/2" x 100'/30m Double Duty Inage Gauging Tape	1
204-58914	1/2" x 25' Double Duty Inage Refill	1
204-58916	1/2" x 33' Double Duty Inage Refill	1
204-58920	1/2" x 50' Double Duty Inage Refill	1
204-58922	1/2" x 66' Double Duty Inage Refill	1
204-58924	1/2" x 75' Double Duty Inage Refill	1
204-58926	1/2" x 100' Double Duty Inage Refill	1

## Gauging Accessories

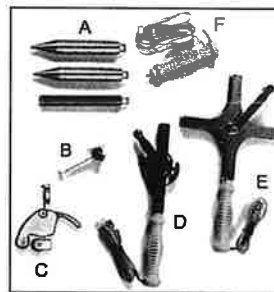

- A. Inage and Outage Plumb Bobs
- B. Y-9 Wiper Assembly
- C. Line Wiper
- D. Small Frame Assembly
- E. Large Frame Assembly
- F. Grounding Wire Handle and Clip

Part No.	Description	Std. Pkg.
204-58899	20 OZ. Brass Inage Plumb Bob	1
204-58877	Line Wiper	1



## Extreme All-Weather Cords

The Extreme all-weather extension cord is constructed of 100% TPE (thermo-plastic elastomer) compound which guarantees maximum flexibility as well as abrasion and oil resistance.

- For indoor/outdoor use
- Ultra Flexible
- Lighted end
- Three conductor grounded
- Made in the USA!



Part No.	Ga/Cond	Length (FT)	125V Rating	Weight (LBS)	UPC Code 0-44882-	Std. Pkg.
175-98025	14/3	25	15A	14	70012-2	6
175-98050	14/3	50	15A	18	70013-9	4
175-98100	14/3	100	13A	18	70014-6	2

## Temp-Flex-35™ Vinyl Cord Sets

Temp-Flex-35™ was developed to meet the demands of contractors for a super flexible vinyl cord set. Specially formulated SJTW vinyl outer jacket won't crack or break, even at temperatures as low as -35° F. Highly visible yellow color for safety.

- Three conductor grounded
- Yellow cord
- 300V



Part No.	Ga/Cond	Length (FT)	125V Rating	Weight (LBS)	UPC Code 0-44882-	Std. Pkg.
175-68100	10/3	100	15A*	48	42594-0	2

\*Plugs rated 15A

## Power-On™ Temp-Flex-35™ Cord Sets

Same construction as Temp-Flex-35 cord set with the addition of power indicator light to show when power is on. Designed with convenience in mind, easily seen in day or night.

- Power-On™ indicator light lets you know when power is running
- Three conductor grounded
- Yellow cord with Power-On™ illuminated plug - 300V



Part No.	Ga/Cond	Length (FT)	125V Rating	Weight (LBS)	UPC Code 0-44882-	Std. Pkg.
175-74050	12/3	50	15A	16	40007-7	2
175-74100	12/3	100	15A	31	40008-4	2

## Outdoor Round Cord Sets

SJTW, medium flexibility vinyl cord set.

- Three conductor grounded
- Orange cord - 300V



Part No.	Ga/Cond	Length (FT)	125V Rating	Weight (LBS)	UPC Code 0-44882-	Std. Pkg.
175-65025	12/3	25	15A	8	42570-4	2
175-65050	12/3	50	15A	16	42575-9	2
175-65100	12/3	100	15A	31	42580-3	2





## Temp-Flex-35™ Triple Outlet Pow-R-Block™ with GFCI Plug

Temp-Flex low temperature SJTW, yellow cord with a permanently molded Pow-R-Block outlet at one end and a GFCI plug at the other. Plug has both reset and manual test buttons and is rainproof.

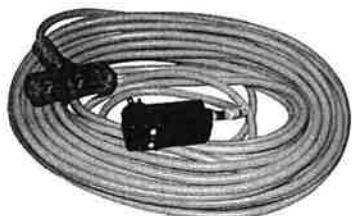

Part No.	Ga/Cond	Length (FT)	125V Rating	Weight (LBS)	UPC Code 0-44882-	Std. Pkg.
175-50024	12/3	2	15A	12	42724-1	12

## Portable Trouble Lights

Grounded metal bulb cage and hook. Grounded outlet on handle, SJT wire type with orange cord.



- Three conductor trouble light with outlet
- Grounded metal cage

Part No.	Ga/Cond	Length (FT)	125V Rating	Weight (LBS)	UPC Code 0-44882-	Std. Pkg.
175-TL525	16/3	25	13A	26	42028-0	12
175-TL550	16/3	50	13A	22	42030-3	6



**SMART STRAW**  
NEVER LOSE THE STRAW AGAIN.

## Lubricants/Penetrants/Degreasers

Known as "the can with a thousand uses," WD-40 protects metal from rust and corrosion, penetrates stuck parts, displaces moisture, and lubricates just about anything. WD-40 is also great when it comes to cleaning grease, grime, and other marks from most surfaces.

**Smart Straw** - Features a permanently attached straw that sprays two ways. Simply flip it up for a precision stream and down for regular spray action. "Never lose the straw again."

**Big Blast** - New wide area spray nozzle, designed to deliver product quickly and efficiently over large areas.



011-110054



011-110078



011-110184

Part No.	Description	Std. Pkg.
011-110054	8 Oz. Smart Straw WD-40 Aerosol	12
011-110078	11 Oz. Smart Straw WD-40 Aerosol	12
011-110184	20 Oz. Trigger Pro WD-40 Non-Aerosol	12



## Lubricants/Penetrants/Degreasers (Cont.)



011-10116



011-10124



011-10110



011-10117



011-10118



011-10100

Part No.	Description	Std. Pkg.
011-10100	Spray Applicator Bottle (Empty)	4
011-10110	1 Gallon, WD-40	4
011-10116	16 Oz. Industrial Size WD-40 Aerosol	12
011-10117	5 Gallon Pail, WD-40	1
011-10118	55 Gallon Drum, WD-40	1
011-10124	18 Oz. Big Blast, WD-40 Aerosol	12



## Lubricants/Penetrants/Degreasers

New from WD-40 company, Blue Works offers a line of industrial grade specialty maintenance products that includes lubricants, penetrants, degreasers and cleaners - all developed especially for industrial users. Blue Works products deliver superior performing formulas that are proven to surpass leading competitor products.



- The only NSF® H1 and H2 certified silicone

011-110238



- Stands up to extreme temperature and pressure, when others fail

011-110245



- Long-lasting
- Extreme pressure and wear protection

011-110252



- Frees stuck and corroded parts and inhibits rust from coming back

011-110269

Part No.	Description	Std. Pkg.
011-110238	Blue Works Silicone 11 Oz.	12
011-110245	Blue Works Dry Lube with PTFE, 10 Oz.	12
011-110252	Blue Works White Lithium Grease	12
011-110269	Blue Works Penetrant, 10 Oz.	12