



Aluminum Bronze (AlBr)

### Pipe Wrenches



• American Type

Part No.	(D Max) inch	(l) inch	Wt. lbs.
040-Ex502-6	3/4	6	0.66
040-Ex502-8	1	8	1.04
040-Ex502-10	1-3/16	10	2.25
040-Ex502-12	1-9/16	12	3.26
040-Ex502-14	2	14	3.59
040-Ex502-18	2-3/8	18	6.28
040-Ex502-24	3	24	10.67
040-Ex502-36	3-3/8	36	17.17
040-Ex502-48	4-3/8	48	29.92

Part No.	(D Max) mm	(l) mm	Wt. kg.
040-Ex501-6	20	150	0.30
040-Ex501-8	25	200	0.47
040-Ex501-10	30	250	1.02
040-Ex501-12	40	300	1.48
040-Ex501-14	50	350	1.63
040-Ex501-18	60	450	2.85
040-Ex501-24	75	600	4.84
040-Ex501-36	85	900	7.79
040-Ex502-48	110	1200	13.57

### Chain Pipe Wrenches

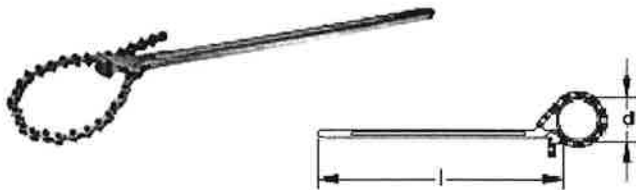

Part No.	(D Max) inch	(l) inch	Wt. lbs.
040-Ex600-2	2	24	3.53
040-Ex600-4	4	24	3.99
040-Ex600-6	6	24	4.39
040-Ex600-12	12	24	5.63

Part No.	(D Max) mm	l mm	Wt. kg.
040-Ex600-2	50	600	1.60
040-Ex600-4	100	600	1.81
040-Ex600-6	150	600	1.99
040-Ex600-12	300	1830	2.56

### Groove Joint Pliers



Part No.	(A Max) inch	(l) inch	Wt. lbs.
040-Ex604-10	1-1/8	10	0.75
040-Ex604-12	1-7/8	12	1.21
040-Ex604-14	2-3/16	14	2.60
040-Ex604-16	3-3/16	17-3/16	3.66

Part No.	(A Max) mm	(l) mm	Wt. kg.
040-Ex604-10	28	250	0.34
040-Ex604-12	48	300	0.55
040-Ex604-14	55	350	1.18
040-Ex604-16	80	430	1.66

### Adjustable Combination Plier



Part No.	l inch	Wt. lbs.	l mm	Wt. kg.
040-Ex605-8	8	0.46	200	0.21

### Square Point Shovel with Long Handle



• Handle Length 47"

Part No.	(A) inch	(B) inch	Wt. lbs.
040-Ex1005-250	10	12	2.56

Part No.	(A) mm	B mm	Wt. kg.
040-Ex1005-250	250	300	1.16

### Round Point Shovel with Long Handle



• Handle Length 47"

Part No.	(A) inch	(B) inch	Wt. lbs.
040-Ex1006-243	9-11/16	12	2.82

Part No.	(A) mm	B mm	Wt. kg.
040-Ex1006-243	243	300	1.28



Aluminum Bronze (AlBr)

### Flange Wedge

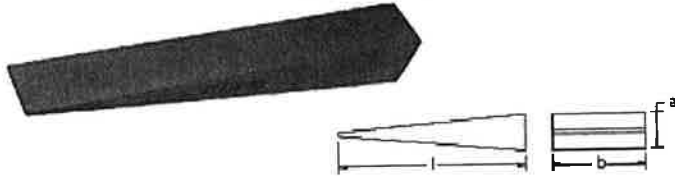

Part No.	(A) inch	(B) inch	(l) inch	Wt. lbs.
040-Ex1101-1	1/4	9/16	3-3/16	0.04
040-Ex1101-2	1/2	3/4	4-1/16	0.18
040-Ex1101-3	1/2	1	6	0.42
040-Ex1101-4	3/4	1-1/2	6	0.92
040-Ex1101-5	1/2	1-1/4	3-3/16	0.64
040-Ex1101-6	3/4	2	3-3/16	1.56
040-Ex1101-7	1-5/8	1-1/2	8	2.50
040-Ex1101-8	1	1-1/2	8	1.72
040-Ex1101-9	3/4	2	8	1.66
040-Ex1101-10	1-1/4	2	8	2.96
040-Ex1101-12	3/8	2	3-9/16	0.40
040-Ex1101-13	1/2	1-1/8	4-1/2	0.88
040-Ex1101-14	3/4	1-1/2	9	2.19
040-Ex1101-15	3/4	1-1/4	6	1.38
040-Ex1101-16	3/4	2	6	2.00
040-Ex1101-17	5/16	1	6	0.82

### Banana Wedge

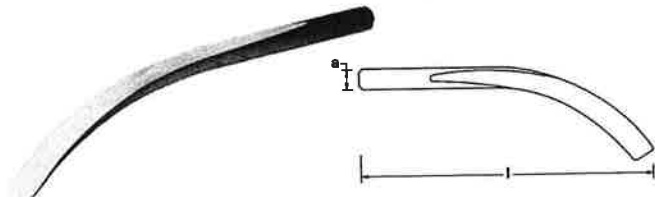

• Copper Beryllium (Cube)

Part No.	(B) inch	(l) inch	Wt. lbs.
040-Ex1101B-20B	3/4	12	1.6

### Pinch Bar

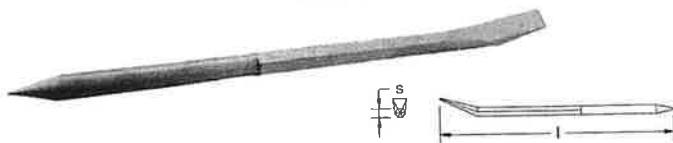

Part No.	(S) inch	(l) inch
040-Ex1301-750	1	31

### Flange Spreader

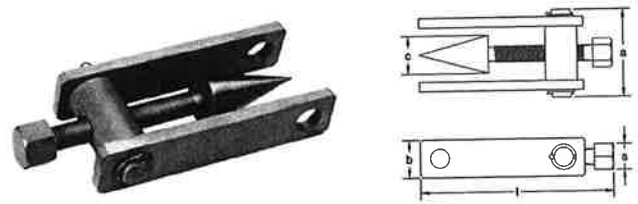

Part No.	(A) inch	(B) inch	(C) inch	(S) inch	(l) inch	Wt. lbs.
040-Ex1102-60	5-9/16	2-3/8	2-3/8	1-13/16	12-3/16	14.53

Part No.	(A) mm	(B) mm	(C) mm	(S) mm	(l) mm	Wt. kg.
040-Ex1102-60	140	60	60	46	305	6.59



### Locking Pliers

- Constructed of high-grade heat-treated alloy steel for maximum toughness and durability
- Ideal for awkward shaped pieces
- Turn screw to adjust pressure and fit work. Stays adjusted for repetitive use
- Guarded release trigger quickly unlocks and protects from accidental release

### Helical Curved Jaw Locking Pliers



Part No.	Type	Size	Jaw Adjustment
171-94-155	CRW5	5" / 125 mm	0 - 15/16" / 0 - 23.8 mm
171-94-157	CRW7	7" / 175 mm	0 - 1-5/8" / 0 - 41.3 mm
171-94-150	CRW10	10" / 250 mm	0 - 1-7/8" / 0 - 47.6 mm

### Straight Jaw Locking Pliers



Part No.	Type	Size	Jaw Adjustment
171-94-167	CR7	7" / 175 mm	0 - 1-1/8" / 0 - 28.6 mm
171-94-550	CR10	10" / 250 mm	0 - 1-1/2" / 0 - 38.1 mm

## CROSSMAN

### Locking Pliers (Cont.)

#### Long Nose Locking Plier



- Constructed of high-grade heat-treated alloy steel for maximum toughness and durability
- Ideal for for clamping, tightening, turning, and twisting
- Turn screw to adjust pressure and fit work. Stays adjusted for repetitive use
- Guarded release trigger quickly unlocks and protects from accidental release

Part No.	Type	Size	Jaw Adjustment
171-94-176	CLN6	6" / 150 mm	0 - 1-5/8" / 0 - 41.3 mm

### Locking C-Clamps

#### Locking C-Clamps with Regular Tips



- Constructed of high-grade heat-treated alloy steel for maximum toughness and durability
- Turn screw to adjust pressure and fit work. Stays adjusted for repetitive use
- Guarded release trigger quickly unlocks and protects from accidental release
- Perfect for safe clamping of long reach materials in auto body, construction, sheet metal and welding

Part No.	Type	Size	Jaw Adjustment	Throat Depth
171-94-246	CR6	6"/150 mm	0-2"/0-50.8 mm	1-3/8"/35 mm
171-94-251	CR11	11"/275 mm	0-3-3/4"/0-95.3 mm	2-1/2"/63.5 mm
171-94-258	CR18	18"/455 mm	0-6-1/8"/0-155.5 mm	9-1/2"/241.3 mm

### Locking C-Clamps with Swivel Pad Tips



- Constructed of high-grade heat-treated alloy steel for maximum toughness and durability
- Swivel pads prevent damage to soft materials
- Turn screw to adjust pressure and fit work. Stays adjusted for repetitive use
- Guarded release trigger quickly unlocks and protects from accidental release
- Perfect for safe clamping of long reach materials in auto body, construction, sheet metal and welding

Part No.	Type	Size	Jaw Adjustment	Throat Depth
171-94-266	CSP6	6"/150 mm	0-2"/0-50.8 mm	1-1/4"/31.7 mm
171-94-271	CSP11	11"/275 mm	0-3-3/4"/0-95.3 mm	2-1/2"/63.5 mm
171-94-278	CSP18	18"/455 mm	0-5-1/2"/0-139.7 mm	9-1/2"/241.3 mm

### Special Locking Clamps

#### Locking Welding Clamp

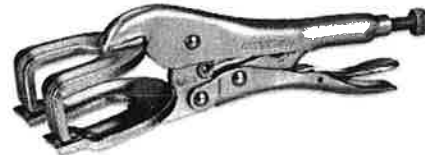

- Constructed of high-grade heat-treated alloy steel for maximum toughness and durability
- U-shaped jaws offer enhanced visibility & more working space
- Micro-adjustment screw transfers proper pressure to change jaw opening, holds workpiece in proper alignment, and stays adjusted for repetitive use
- Guarded release trigger quickly unlocks and protects from accidental release.
- Powerful locking mechanism

Part No.	Type	Size	Jaw Adjustment	Throat Depth
171-94-239	CR9	9" / 225 mm	2-3/4" / 69.8 mm	2-3/16" / 55.5 mm

## CROSSMAN

### Special Locking Clamps (Cont.)

#### Locking Chain Clamp



- Constructed of high-grade heat-treated alloy steel for maximum toughness and durability
- Chain holds and locks around any shape or size
- Turn screw to adjust pressure and fit work. Stays adjusted for repetitive use
- Guarded release trigger quickly unlocks and protects from accidental release.

Part No.	Type	Size	Effective Chain Length
171-94-280	CR20	9" / 228 mm	18" / 457 mm



### Threadlockers

#### Medium Strength Threadlocker

- All purpose
- For most nut and bolt applications
- **Use on:** Tools, pumps, compressors, gear boxes, bolts (mounting, pulley, coupling)
- Break/prevail: 115/93



Part No.	Description	Std. Pkg.
196-C-24210	1/4" to 3/4" (6 to 20 mm) 10 ml (carded)	6
196-C-24250	1/4" to 3/4" (6 to 20 mm) 50 ml	6

#### High Strength Threadlocker

- Ideal for harsh chemical or environmental conditions
- **Use on:** Cylinder block bolts, transmission shaft bolts, ring gear bolts, frame bolts, hydraulic press studs
- Break/prevail: 239/266



Part No.	Description	Std. Pkg.
196-C-27110	3/8" to 1" (10 to 25 mm) 10 ml (carded)	6
196-C-27150	3/8" to 1" (10 to 25 mm) 50 ml	6

### Silicone Gasket Makers & Sealants

#### SuperPure™ Professional RTV Silicone Gasket Maker



196-C-951 196-C-952 196-C-953 196-C-956

- Oxygen sensor-safe
- Forms instant leakproof gaskets on all engines
- Low volatile formula meets GM 9985443 spec
- Pressure resistant
- Great adhesive and sealant for many materials, metal, glass, plastic, wood, rubber, fiberglass, etc.

Part No.	Description	Std. Pkg.
196-C-951	Black, 3 oz. / 85 g	12
196-C-952	Red, 3 oz. / 85 g	12
196-C-953	Clear, 3 oz. / 85 g	12
196-C-956	Blue, 3 oz. / 85 g	12

### Severe Weather & Storage

#### Air Brake Anti-Freeze & Dryer



196-C98 196-C97

- Dissolves ice on contact
- Year-round protection for air brake systems
- Moisture remover

Part No.	Description	Std. Pkg.
196-C-97	Air Brake Anti-Freeze & Dryer, 32 fl. oz. / 946 ml	12
196-C-98	Air Brake Anti-Freeze & Dryer, 1 gal. / 3.79 liter	4



## Severe Weather & Storage (Cont.)

### Windshield Washer

#### 100% Concentrate Windshield Washer Cleaner & Anti-Freeze

- All-season product: winter anti-freeze and summer cleaner
- 100% concentrate formula (many competitive products on the market are 40% water)
- User may custom blend solvent to match weather conditions

196-C-207



#### Concentrated Windshield Washer Solvent With Ammonia

- Removes bugs, road film and grime
- Add to windshield washer fluid reservoir
- Easy-to-use 6 ounce bottle - use 1 oz. per 1 quart of water

196-C-206



Part No.	Description	Std. Pkg.
196-C-207	Washer Cleaner & Anti-Freeze, 16 fl. oz. / 473 ml	6
196-C-206	Washer with Ammonia, 16 fl. oz. / 177 ml	24

## Greases

### #2 Lithium Grease

Multi-purpose protection for damp environments and heavy loads. Protection for bearings (plain, roller and ball), suspension points, ball joints, universal joints, steering linkages and chassis. Ideal for general plant use.

- Formulated with lithium soap high quality base oils
- Dropping point 350°F (175° C)
- N.L.G.I. grade 2
- Added rust and oxidation inhibitors

196-C-GR22



Part No.	Description	Std. Pkg.
196-C-GR22	#2 Lithium Grease 16 oz. / 454 g	12

## Protectants

### Heavy Duty Belt Dressing

- Stops squeaks and adds traction
- Protects against further slippage
- For fan belts and motor-driven belts
- Helps condition and preserve new and used belts
- Protects against drying and cracking

196-C-124-6



Part No.	Description	Std. Pkg.
196-C-124-6	Belt Dressing, 8 oz. net wt. / 22.6 g	6

## Lubricants & Penetrants

### Heavy Duty Break • Away®

- Fast penetrating oil and lubricant
- Breaks loose rusted joints and bolts
- Controls rust, corrosion and squeaks
- Contains no silicone - pure oil blend
- NSF certified



196-C-10

Part No.	Description	Std. Pkg.
196-C-10	Break Away® Fast Penetrating Oil, 13 Oz. 12/Case	

### Red Grease™

- Waterproof - resistant to wash off
- Aluminum complex red grease protects and lubricates all types of industrial bearings, striker plates, chains and cables, etc.
- Chemical resistant properties - withstands attack from acids, salt sprays, etc.
- High temperature up to 400°F (200°C) and high load bearing strength
- Red color provides easy visual inspection



196-C-123

Part No.	Description	Std. Pkg.
196-C-123	Red Grease™, 10.5 Oz.	12/Case



## Brake Products

### Brake & Parts Clean®



196-C-111

- Quick drying and super strong cleaner
- Eliminates chlorinated solvent concerns in waste oil disposal

Part No.	Description	Std. Pkg.
196-C-111	Brake & Parts Clean® Non-Chlorinated, 14 Oz.	12/Case

## Anti-Seize

### Heavy Duty Anti • Seize

Extreme pressure lubricating blend of graphite, copper and aluminum.



196-C-682

- Exceeds MIL-A-907E
- Protects metal parts from extreme heat, pressure, rust and corrosion
- Prevents galling, seizing and pitting
- Reduces wear, friction and torque
- Ensures accurate torque and easy disassembly

Part No.	Description	Std. Pkg.
196-C-682	Heavy Duty Anti-Seize, 8 Oz.	12/Case

# DURACELL®

## Procell® Alkaline Batteries



165-PC1300



165-PC1400



165-PC1500



165-PC1604



165-PC2400

Part No.	Description	Std. Pkg.
165-PC1300	Duracell Procell D Alkaline Batteries	12
165-PC1400	Duracell Procell C Alkaline Batteries	12
165-PC1500	Duracell Procell AA Alkaline Batteries	24
165-PC1604	Duracell Procell 9V Alkaline Batteries	12
165-PC2400	Duracell Procell AAA Alkaline Batteries	24

## Copper Top Alkaline Batteries



165-MN1400



165-MN2400



165-MN908

Part No.	Description	Std. Pkg.
165-MN1400	Duracell C Alkaline Batteries	12
165-MN2400	Duracell AAA Batteries	24
165-MN908	Duracell 6V Lantern Battery	6

## EASYHEAT®

### Cables

#### AHB Water Pipe Heating Cable



Each AHB cable consists of a tough XLPE inner insulation, a continuous ground braid and weather resistant PVC outer jacket. AHB units are activated and de-activated by an integral energy-saving thermostat. Each cable is UL listed to Canadian safety standards and CSA certified when used in accordance with instructions on water-filled metal or plastic pipes.

- Fixed resistance
- Pre-Terminated

Part No.	Description	UPC	Ctn. Qty.	Ctn. Wt.
140-AHB013	3' length, 21 watts	0-13627-10950-6	10	6
140-AHB016	6' length, 42 watts	0-13627-10951-3	10	7
140-AHB019	9' length, 63 watts	0-13627-10952-0	10	9
140-AHB112	12' length, 84 watts	0-13627-10953-7	10	10
140-AHB115	15' length, 105 watts	0-13627-10954-4	10	11
140-AHB118	18' length, 126 watts	0-13627-10955-1	5	7
140-AHB124	24' length, 168 watts	0-13627-10956-8	5	8
140-AHB130	30' length, 211 watts	0-13627-10957-5	5	9
140-AHB140	40' length, 280 watts	0-13627-10958-2	5	12
140-AHB160	60' length, 420 watts	0-13627-10959-9	5	15
140-AHB180	80' length, 560 watts	0-13627-10960-5	5	20

### Freeze Free® Cables & Accessories



This self-regulating pipe heating cable automatically varies its heat output with changes in surrounding temperature. Freeze Free® cable helps keep plastic and metal water pipes from freezing to -60°F/51°C. A braided metal jacket provides an electrical ground as well as protection against damage in dry locations. Freeze Free® cable can be cut to desired lengths per application. Cables are rated at 3 watts per foot, 120 vac at 50°F/10°C; 75-foot maximum circuit length, 3-foot minimum circuit length. Freeze Free® cable is UL listed to US and Canadian safety standards and CSA certified.

- Self-Regulating
- Cut-to-length Cable

Part No.	Description	UPC	Ctn. Qty.	Ctn. Wt.
140-2302	300' Reel Freeze Free®	0-13627-06896-4	1	13
140-10803	Connection Kit - Polybagged Pkg.	0-13627-10803-5	25	5

### Freeze Free® Preset Thermostat



The pre-set thermostat automatically energizes the heating cable at temperatures lower than 38°F/3°C, eliminates the need for unplugging heating cables each spring and reduces the risk of frozen pipes. EH38 can control other electrical devices that need to be activated when the temperature approaches the freezing point. It is rated at 15 amps, with resistive load at 125 vac. The pre-set thermostat is UL listed to US and Canadian safety standards.

Part No.	Description	UPC	Ctn. Qty.	Ctn. Wt.
140-EH38	Pre-set Thermostat	0-13627-09938-8	10	3



## Energizer Industrial

### Alkaline Batteries

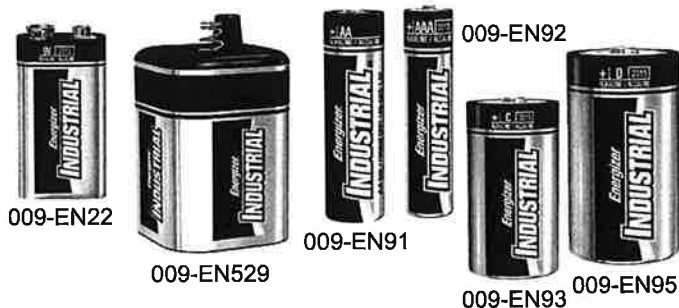

Part No.	Description	Std. Pkg.	Inner Pkg.
009-EN22	9V Alkaline Battery	72	12
009-EN529	6V Alkaline Battery	6	1
009-EN91	AA Alkaline Battery	144	24
009-EN92	AAA Alkaline Battery	144	24
009-EN93	C Alkaline Battery	72	12
009-EN95	D Alkaline Battery	72	12

### Super Heavy Duty Batteries



Part No.	Description	Std. Pkg.	Inner Pkg.
009-1209	6V Super HD, Spring Top	12	1
009-1212	AAA Super HD	48	12
009-1215	AA Super HD	192	24
009-1222	9V Super HD	72	12
009-1231	6V Super HD, Screw Top	6	1
009-1235	C Super HD	192	12
009-1250	D Super HD	192	12
009-510S	6V Screw Terminal	12	1

## Energizer Lithium

### Lithium Batteries



Part No.	Description	Std. Pkg.
009-L91BP-8	AA Lithium Batteries	8
009-LPBP-4	AAA Lithium Batteries	4
009-EL123APB-2	Lithium Photo Batteries	2

## Industrial Flashlights

### Industrial Yellow

- Chemical resistant polypropylene
- Heavy-duty ribbed construction
- Shockproof
- Hanger hook in end cap
- Shatterproof lens
- Non-conductive



Part No.	Description	Std. Pkg.
009-1151	HD Industrial Flashlight, 2AA Cell	12
009-1251	HD Industrial Flashlight, 2D Cell	12
009-1351	HD Industrial Flashlight, 3D Cell	12
009-5109IND	HD Industrial Floating Lantern	12
009-E250Y	HD Industrial Flashlight, 2D Cell	12
009-E251Y	HD Industrial Flashlight, w/Magnet, 2D Cell	12





## Industrial Flashlights (Cont.)

### Safety Orange

- UL/MSHA/CSA approved
- Orange safety color
- Chemical resistant polypropylene
- Heavy duty ribbed construction
- Shockproof
- Hanger hook in end cap



009-1259



009-1359



009-459



009-2311ND



009-91011ND

Part No.	Description	Std. Pkg.
009-1259	HD Safety Flashlight, 2D Cell	12
009-1359	HD Safety Flashlight, 3D Cell	12
009-459	HD Safety Lantern, 6V Batt. Not Included	6
009-2311ND	Lantern w/Flasher, 6V Batt. Not Included	6
009-91011ND	Sealed Beam Lantern, 6V Not Included	6



The toughest lights you will ever need. Sums up Energizer Hard Case Professional brand promise. The Hard Case Pro Series is built with impact-resistant ABS plastic, reinforcing ribs, rubber overmold, stainless steel plates, high performance LED light sources and shatterproof lenses.



009-TUF2AAPE



009-TUF2DPE



009-TUF4AAPE



009-TUF421PE



009-TUF4CPE

Part No.	Description	Std. Pkg.
009-TUF2AAPE	Hard Case Pro Flashlight, 2AA Cell	6
009-TUF4AAPE	Hard Case Pro Flashlight, 4AA Cell	6
009-TUF2DPE	Hard Case Pro Flashlight, 2D Cell	6
009-TUF421PE	Hard Case Pro Flashlight, 4AA Cell	6
009-TUF4CPE	Hard Case Pro Spot Light, 4C Cell	4

## Personal Fall Protection

### Harnesses

#### Oil Rigger's Harness Kit

To meet the needs of the oil rigger, Elk River offers a SaddleMaster-style harness designed with a D-ring at the center back of waistbelt for restraint. SaddleMaster-style harness with four D-rings: Sliding D-ring at center of back, D-ring on each end of seat strap, non-removable waist-belt with one D-ring at center of back, includes black Carry-all bag.



Part No.	Size	Std. Pkg.
090-76471	S	6
090-76472	M	6
090-76473	L	6
090-76474	XL	6
090-76475	2XL	6
090-76476	3XL	6

#### Universal® Harness

- Three steel D-rings located at back and hips
- Parachute mating buckles on chest strap
- Tongue buckles on leg straps
- Made of polyester and nylon

Part No.	Size	Std. Pkg.
090-42359	One Size Fits Most (M-2XL)	1



Personal Fall Protection

## Lanyards

### Zorber® Lanyards

- Nylon web
- Energy absorbing

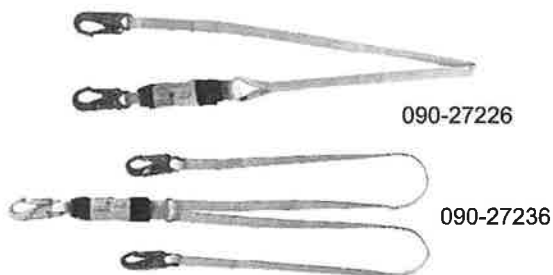

Part No.	Description	Std. Pkg.
090-27226	1" x 6', 13102 Snaphook ea. end	1
090-27236	1" x 6', Twin Leg, 13102 Snaphook ea. leg	1

### CenturionZ™ Zorber® Web Lanyard

- 3.6 M Gate
- Energy-Absorbing
- Nylon Web



Part No.	Description	Std. Pkg.
090-36357	1" x 6', Twin Leg, Z snaphook and Rebar Hook on each leg, 3.6M Gate	1

### CenturionZ™ Rope Lanyard

- Rope, positioning
- 3.6M Gate



Part No.	Description	Std. Pkg.
090-28013	1/2" x 3', Z snaphook each end, 3.6M Gate	1

## Rope Positioning Lanyards

- Nylon Rope, Positioning



Part No.	Description	Std. Pkg.
090-25003	1/2" x 3', Snaphook on each end	1
090-25004	1/2" x 4', Snaphook on each end	1
090-25006	1/2" x 6', Snaphook on each end	1

## Web Positioning Lanyards

- Nylon Web, Positioning



Part No.	Description	Std. Pkg.
090-26006	1" x 6', Snaphook on each end	1

## Flex-NoPac™ Web Lanyards

- Polyester Web
- Energy-Absorbing



Part No.	Description	Std. Pkg.
090-35426	1-1/2" x 6' Flex-No Pac™ Shock-absorbing Centurion Lanyard	1
090-35476	1-1/2" x 6' Flex-No Pac™ Shock-absorbing Centurion Lanyard with 13120 & 13207	1

*Personal Fall Protection*

## Rebar Assemblies

### Rebar Chain Assembly

- One swivel formhook
- Two 3/4" Centurion snaphooks
- Provides hands-free positioning



Part No.	Description	Std. Pkg.
090-13425	25-1/2", Swivel Zrebar Hook, Z snaphooks on each leg, 3.6M Gate	1

### Rebar Web Assembly



Part No.	Description	Std. Pkg.
090-29761	1" x 18" with two 13120 Snaphooks and 13328 Swivel Form Hook	1

## Hardware

### Fall-Rated Snaphooks



090-13100



090-13101



090-13128



090-13321

Part No.	Description	Std. Pkg.
090-13100	Double-locking snaphook, 5" x 2-1/4" x 3/4" Fall-Rated	1
090-13101	Centurion Z snaphook, 5" x 2-1/2" x 3/4" Gate Opening, Fall-Rated, 3600 lb., 3.6M Gate	1
090-13128	Pincer™ Snaphook, 6" x 3-1/4" x 3/4" Gate Opening, Fall-Rated, 3600 lb., 3.6M Gate	1
090-13321	Centurion Z swivel snaphook, fall indicator, Autolock, 7-3/4" x 2-3/4" x 3/4" Gate Opening Fall-Rated, 3600 lb., 3.6M Gate	1

## Carabiners



090-17426



090-17443

Part No.	Description	Std. Pkg.
090-17426	Auto Twist-lock, Pin 1/2" x 7-1/2" x 4-1/2" x 2-1/4" Gate Opening, Fall-Rated, 3600 lb., 3.6M Gate	1
090-17443	Auto Twist-lock, Pin 1/2" x 4" x 2-1/24" x 1" Gate Opening, Fall-Rated, 3600 lb., 3.6M Gate	1

## Miscellaneous

### Bosun's Seat

Laminated plywood with a four point nylon suspension system, 13003 D-ring attachment point, waistbelt, plus two bucket snaps each end for attaching equipment.

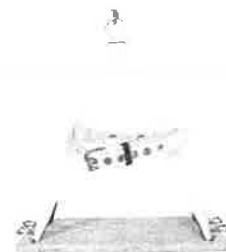

Part No.	Description	Size	Std. Pkg.
090-85824	Deluxe Bosun's Seat, 12" x 24" Platform seat of 1"	S-XL	1

## Anchorage

### EZE Man™ Sling



Part No.	Description	Std. Pkg.
090-26773	1-3/4" x 3' EZE Man™ Sling with Triangle and D-Ring Ends	1

## **GASOILA** CHEMICALS

### Thread Sealants

#### Soft-Set Thread Sealant with PTFE

- Soft-setting, non-toxic, PTFE paste
- Provides a positive seal on pipe threads, joints, fittings, hoses, nozzles, LPG cylinders, pump assemblies, oil burners, hydraulics, compressors, engines, motors, housing, plugs, fuel lines, couplings and more
- Use on brass, copper, stainless steel, aluminum, black pipe, tin, galvanized, ABS, CPVC, PVC plastics, nylon, polyethylene, polypropylene, polybutylene and more
- Not for use on oxygen
- Remains pliable in cold temperatures
- Temperature Range: -100°F to 600°F (-74°C to 318°C)
- Pressure Range: To 10,000 psi sealing liquids; to 3,000 psi sealing gases
- One year shelf life when stored at 40°F to 80°F (5°C to 27°C)
- For alcohol blended gasoline (ethanol)
- For use on NPT Threads



Part No.	Description	Std. Pkg.
179-SS32	1 Qt. Flat Top	6

### Gauging Pastes

#### All Purpose Water Finding Paste



- Fast, reliable way to detect water in fuel storage tanks
- Accurately detects phase separation in ethanol blend applications
- For all petroleum fuels including ethanol and methanol blends, diesel, kerosene, #2 oil, JP-4, JP-5 and more
- Works in seconds, even in extreme temperature conditions
- Paste will turn yellow-green upon contact with water

Part No.	Description	Std. Pkg.
179-AP02	2 oz. Tube	6

### Regular Water Finding Paste



- Reformulated for better consistency and improved color change
- Quickly and accurately detects water in fuel storage tanks
- Mustard yellow paste will turn red upon contact with water
- Effective with gasoline, diesel or other hydrocarbon products, sulphuric, nitric and hydrochloric acids, ammonia, soap solutions and other chloride solutions

Part No.	Description	Std. Pkg.
179-WT25	2.5 oz. Tube	24

### Gas Gauging Paste

- Indicates level of gasoline, naphtha, kerosene, crude and refined oils, jet fuels and a range of other commonly stored liquids
- Paste will turn from green to white upon contact with gasoline



Part No.	Description	Std. Pkg.
179-GG25	2.5 oz. Jar	24

### Tub-O Towels Cleaners

- 90 count tub contains 10 x 12 sheets for big spills or messes
- More towels than the competition



Part No.	Description	Std. Pkg.
179-TW90	Tub of 90 Towels	6



The best quality industrial first aid supplies at competitive prices. First Aid Only is a trusted name in the industrial industry and especially towards the oilfield. All kits meet or exceeds federal OSHA regulation 1910.151B (states may vary).

## First Aid Kits

### Plastic Case Models



097-222-U or 223-U



097-225-AN or 225-U

### Metal Case Models



097-224-U



097-226-U

### Snake Bit Kit



155-205033LFA

Part No.	Description	Std. Pkg.
097-222-G	10 Person, Plastic Case w/Gasket	12
097-222-U	10 Person, Plastic Case w/Dividers	10
097-223-G	25 Person, Plastic Case w/Gasket	12
097-223-U	25 Person, Plastic Case w/Dividers	10
097-224-U	25 Person, 106 pc., Metal Case	12
097-225-AN	50 Person, ANSI Kit, Plastic w/Divider	6
097-225-U	50 Person, 196 Pc., w/ Plastic Case	6
097-226-U	50 Person, 196 Pc., w/Metal Case	6
155-205033LFA	Snake Bite Kit	1

## Burn Care Kits



### Burn Care First Aid Kits 11 Piece Kit

Part No.	Description	Qty.
097-440-0	M-5032-10 unit plastic case w/gasket, 7-11/16" x 4-9/16" x 2-3/8"	1 ea.
	Bulk-3" x 5 yd. bandage wrap you can tear, latex free	1 ea.
	Bulk-3" conforming gauze roll bandage, sterile	1 ea.
	Bulk-1" x 5 yd. first aid tape roll	1 ea.
	M-490-4" x 16" Water-Jet® burn dressing	1 ea.
	M-489-4" x 4" Water-Jet® burn dressings	2 ea.
	Bulk-Exam quality vinyl gloves, 2 pairs	4 ea.
	Bulk-4-1/2" Scissors, nickel plated	1 ea.



## Personal Protection



### Personal Protection Kit 13 Piece Kit

Part No.	Description	Qty.
097-213-U	Plastic case, 9" x 8-3/8" x 2-1/2"	1 ea.
	Disposable gown w/full sleeves	1 ea.
	Disposable shoe covers	2 ea.
	Disposable bonnet	1 ea.
	Eye shield with ear loop mask	1 ea.
	Exam quality vinyl gloves, 1 pair	2 ea.
	24" x 24" Biohazard bag, 10 gallon capacity	1 ea.
	Clear bag w/twist tie	1 ea.
	Antiseptic cleansing wipes (sting free)	3 ea.



## Safety Slide Chair

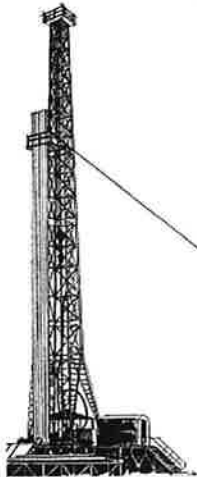

Dedicated to providing a dependable quality product for use in the oil field to allow safe escape from derrick or tower in an emergency situation.

Part No.	Description	Std. Pkg.
076-100190	Geronimo Safety Slide Chair	1
076-100193	Geronimo Latch Pin	12



## Fuller's Earth



For use as an absorbent decolorizer polishing agent filtering medium.

Part No.	Description	Std. Pkg.
028-096712	12 oz. Fuller's Earth	12



**Gatorade** is a scientifically formulated fluid replacement beverage designed to encourage fluid consumption, to optimize fluid absorption and electrolyte replacement, and to deliver fuel needed by exercising muscles.



1 Gallon



2-1/2 Gallon

### 1 Gallon - Powder

Part No.	Flavor	Pkg.
169-03808	Fruit Punch	40 - 8.5 oz.
169-03956	Lemon-Lime	40 - 8.5 oz.
169-03957	Orange	40 - 8.5 oz.
169-33302	Fierce Grape	40 - 8.5 oz.
169-33665	Riptide Rush	40 - 8.5 oz.

### 2-1/2 Gallon - Powder

Part No.	Flavor	Pkg.
169-03944	Variety Pack - LL, FP, O, RR	32 - 21 oz.
169-03969	Lemon-Lime	32 - 21 oz.
169-03970	Orange	32 - 21 oz.
169-33673	Riptide Rush	32 - 21 oz.
169-33677	Glacier Freeze	32 - 21 oz.
169-33691	Fruit Punch	32 - 21 oz.

# Oilfield Supplies

114



6 Gallon



20 oz.

## 6 Gallon - Powder

Part No.	Flavor	Pkg.
169-03967	Lemon-Lime	14 - 51 oz.
169-03968	Orange	14 - 51 oz.
169-03672	Riptide Rush	14 - 51 oz.
169-33676	Glacier Freeze	14 - 51 oz.
169-33690	Fruit Punch	14 - 51 oz.

## 20 oz. Wide Mouth

Part No.	Flavor	Pkg.
169-20781	Variety Pack - LL, FP, O	24 - 20 oz.
169-32482	Fierce Grape	24 - 20 oz.
169-32486	Glacier Freeze	24 - 20 oz.
169-32488	Riptide Rush	24 - 20 oz.
169-32866	Fruit Punch	24 - 20 oz.
169-32867	Orange	24 - 20 oz.
169-32868	Lemon-Lime	24 - 20 oz.

**Gilmour**  
GARDENING INNOVATION

## Flexogen® Water Hose

- Patented 8-ply construction
- Over 500 PSI burst strength
- Double tire cord reinforced for strength
- Lightweight, coils and handles easily in all weather
- Heavy-duty, crush resistant, full-flo® brass couplings
- Maximum kink resistance
- Polished surface resists abrasions, stains and mildew



Part No.	Description	Std. Pkg.
101-34050	3/4" x 50', Flexogen® Water Hose	4
101-34075	3/4" x 75', Flexogen® Water Hose	2
101-34100	3/4" x 100', Flexogen® Water Hose	1
101-10-58025	5/8" x 25', Flexogen® Water Hose	6
101-58050	5/8" x 50', Flexogen® Water Hose	6
101-58075	5/8" x 75', Flexogen® Water Hose	4
101-58100	5/8" x 100', Flexogen® Water Hose	2

## Heavy Duty Rubber Water Hose

- For extra heavy use; resistant to heat, weather and chemicals
- Withstands hot water up to 180°
- 650 PSI burst strength
- Double cord reinforced
- Extra heavy-duty crush resistant solid brass couplings
- Resists kinks and pressure twists
- Abrasion and weather resistant



Part No.	Description	Std. Pkg.
101-16-34050	3/4" x 50', Heavy Duty Rubber Hose	3

## Premium Sprayers

- Ultraviolet resistant, translucent polyethylene tank
- Extra-wide 3-1/4" mouth opening
- Automatic or manual pressure relief valve
- Fast pressuring, 10" non-corroding polymer pump
- Chemical resistant leakproof Viton® seals in discharge valve and tip
- Heavy-duty 18" rotating brass wand with adjustable brass nozzle
- Extra long 52" premium PVC hose
- Easy to clean in-line filter



101-1000P

101-2000P

101-3000P

Part No.	Description	Std. Pkg.
101-1000P	1 Gallon Sprayer with Adjustable Nozzle	1
101-2000P	2 Gallon Sprayer with Adjustable Nozzle	1
101-3000P	3 Gallon Sprayer with Adjustable Nozzle	1

## Gilmour GARDENING INNOVATION

### Spray Nozzles



101-572TFR

- Insulated red grip w/threaded front for hot or cold water
- Brass head insert for resistance to extremely hot water



101-573TF

- Heavy-duty, full-size, die cast body w/threaded front
- Leak proof seal
- Rust resistant stainless steel spring



101-593

- Molded on black vinyl grip for cushioned comfort
- Heavy-duty, full size, die cast zinc body w/threaded front



101-528

- All brass value stem
- Heavy-duty solid brass construction w/comfortable rubber grip
- Adjustable from fine spray to needle stream to heavy rise

Part No.	Description	Std. Pkg.
101-572TFR	Insulated Red Grip Nozzle	1
101-573TF	Heavy-duty, Nozzle	1
101-593	Molded Black Vinyl Grip Nozzle	1
101-528	Heavy-duty Solid Brass Nozzle	1

### Premium Wide Mouth Sprayer



101-XP10

- 1-1/2 gallon actual capacity
- 1 gallon operating capacity

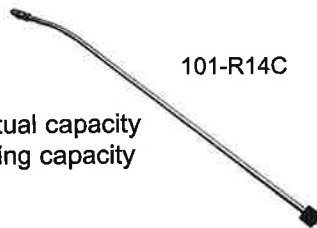

101-R14C

Part No.	Description	Std. Pkg.
101-XP10	1-1/2 Gallon Wide Mouth Sprayer	1
101-R14C	Brass Wand Replacement	1



### Hand Cleaners

#### GOJO® Natural\* Orange™ Pumice Hand Cleaner

Quick-acting lotion formula with pumice scrubbing particles for cleaning a broad range of industrial soils, medium dirt and grease. Orange citrus scent.

(\*Natural citrus ingredient)



190-0955-02



190-0957-12

Part No.	Description	Std. Pkg.
190-0955-02	1 Gallon with Pump Dispenser	2
190-0957-12	14 Fluid Oz. Bottle	12

#### GOJO® Original Formula™ Hand Cleaner

GOJO® Original Formula™ creme contains soothing emollients. For removing heavy grease, tar and oil. Rub, then wipe clean with towel or rinse off.



190-1111-06

Part No.	Description	Std. Pkg.
190-1111-06	4.5 Lb. Plastic Cartridge	6



# Oilfield Supplies

116

## GOLDENROD

### Extra Heavy Duty Pump Oilers

The 120 series oilers provide standards of construction, quality and operating features unmatched by any other hand oiler in the world. The 120 Golden Rod oilers have a zinc die cast hydraulic pressure with a precision machined piston - exclusive with Golden Rod oilers.

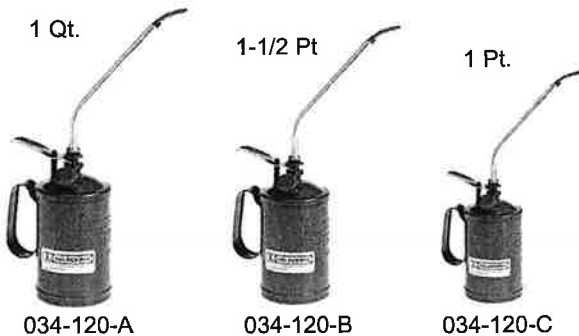

Part No.	Capacity	Spout Type	Spout Lgth.	Spout Part No.
034-120-A	1 Qt.	-	-	-
034-120-A1	1 Qt.	Straight	11"	034-301012
034-120-A2	1 Qt.	Angle	11"	034-301015
034-120-A3	1 Qt.	Flexible	15"	034-301026
034-120-B	1-1/2 Pt.	-	-	-
034-120-B1	1-1/2 Pt.	Straight	9-1/2"	034-301013
034-120-B2	1-1/2 Pt.	Angle	9-1/2"	034-301016
034-120-B3	1-1/2 Pt.	Flexible	12"	034-301025
034-120-C	1 Pt.	-	-	-
034-120-C1	1 Pt.	Straight	7-1/2"	034-301014
034-120-C2	1 Pt.	Angle	7-1/2"	034-301017
034-120-C3	1 Pt.	Flexible	10"	034-301024

### Replacement Spouts - Cap & Gasket for 120 Series

Part No.	Description	Std. Pkg.
034-301012	11" Straight Spout	Bulk
034-301013	9-1/2" Straight Spout	Bulk
034-301014	7-1/2" Straight Spout	Bulk
034-301015	11" Angle Spout	Bulk
034-301016	9-1/2" Angle Spout	Bulk
034-301017	7-1/2" Angle Spout	Bulk
034-301024	10" Flexible Spout	Bulk
034-301025	12" Flexible Spout	Bulk
034-301026	15" Flexible Spout	Bulk
034-301023	Cap & Gasket for 120 Series Oilers	Bulk

### Industrial Series Oilers

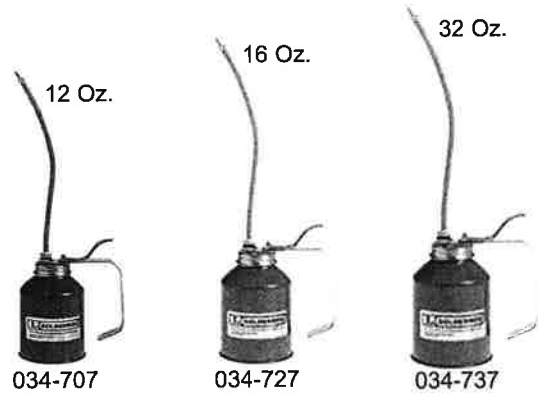

Part No.	Description	Std. Pkg.
034-707	12 Oz. w / 8" Flex Spout	6
034-727	16 Oz. w / 8" Flex Spout	6
034-737	32 Oz. w / 8" Flex Spout	6

### Pistol Pump Oilers



Part No.	Description	Std. Pkg.
034-600	6 Oz. w / 5" Straight Spout	6
034-625	10 Oz. w / 5" Straight Spout	6
034-626	10 Oz. w / 6" Flexible Spout	6
034-630	20 Oz. w / 6" Straight Spout	6

## GOLDENROD®

### Fuel Filters

Golden Rod see-thru bowl filters allow for visual monitoring of the fuel flow. For use with common fuels including regular and unleaded gasoline, diesel, fuel oil and related additives including methyl, ethyl and isopropyl alcohol, compatible w/biodiesel blends up to 20%. Allow working pressures of 150 PSI flows at 5 GPM.

#### 495 Fuel Filter

- For removing microscopic particles (10 microns) or rust, sand, dirt, scale and lint
- 366 sq. inches of filter surface for efficient action
- Unit works well by itself or in combination with the #496 fuel filter for added protection from water in the fuel

034-495



#### 496 Water-Block®

Water Absorbing Fuel Filter Element

- Removes water from gasoline and diesel
- 15 Micron filtration
- Water-absorbing polymers trap water
- May be used by itself or in combination with a #495 fuel filter for added protection against microscopic particle contamination

034-496



Part No.	Description	Std. Pkg.
034-495	Fuel Filter	6
034-496	Water Block® Fuel Filter w/Water Absorbing Filter	6

### Spin-On Fuel Filters

500 series Spin-On models offer a convenient disposable canister. 2 models cover virtually all fuel tank filtering needs. For use with common fuels including regular and unleaded gasoline, diesel, fuel oil and related additives including methyl, ethyl and isopropyl alcohol.

#### 595 Standard Spin-On Fuel Filter

- For use with gasoline, gasohol and diesel fuels
- Filters microscopic particles (10 microns) or rust, sand, dirt, scale and lint
- 510 sq. inches of filtration area
- Maximum working pressure: 50 PSI and/or 12 GPM

034-595



Part No.	Description	Std. Pkg.
034-595	Standard Spin-On Filter, 10 Microns	6
034-595-5	Replacement Canister only, 10 Microns	12

### Spin-On Fuel Filters

#### 596 Water-Block®

- For use with gasoline and diesel fuels
- Filters microscopic particles (10 microns) and absorbs water from fuel
- Restricts fuel flow as water is absorbed, signaling the need for an element change
- 201 sq. inches of filtration area
- Maximum working conditions: 50 PSI and/or 12 GPM

034-596



Part No.	Description	Std. Pkg.
034-596	Water Block® Spin-On Fuel Filter	6
034-596-5	Replacement Canister only, 10 Microns	12

### Fuel Filter Accessories

#### 470 Top Cap - Use with 400 Series

- Heavy Duty Zinc Die Cast
- Available w / 3/4" or 1" NPT pipe fittings

034-470-1



#### 570 Top Cap - Use with 500 Series

- Heavy Duty Zinc Die Cast
- Available w / 3/4" or 1" NPT pipe fittings

034-570-1



Part No.	Description	Std. Pkg.
034-470-1	Top Cap for 400 Series Filters	1
034-570-1	Top Cap for 500 Series Filters	1

#### 15 Micron Replacement Element for 496 Filter

#### 10 Micron Replacement Element for 495 Filter



034-496-5



034-470-5

Part No.	Description	Std. Pkg.
034-496-5	Water Block®, 15 Micron Replacement Element	12
034-470-5	Standard 10 Micron Replacement Element	12

# Oilfield Supplies

## GOLDENROD

### Fuel Filter Accessories (Cont.)

**Stainless Steel 381 Micron Strainer, 40 Mesh**



034-470-15

**Replacement Bowl for 495 & 496 Fuel Filter**



034-495-4

**Fuel Filter Wrench for 495-4 Filter Bowl**



034-491

Part No.	Description	Std. Pkg.
034-470-15	Stainless Steel 381 Micron Strainer	12
034-495-4	Replacement Bowl for 495 & 496	6
034-491	Fuel Filter Wrench for 495-4 Filter Bowl	6

### Fence Stretcher-Splicer

Golden Rod fence stretchers-splicers make repairs easy and are ideal to quickly tighten any fence - high tensile, barbed, or smooth wire. Splice, stretch and reposition wire.

- Original, reliable design



034-400

- Controlled release holds ratchet to reduce line



034-405

- Hired hand fence tool • Patented 3rd hook design
- Allows for longer pulls without resetting the tool



034-415

Part No.	Description	Std. Pkg.
034-400	Standard Fence Stretching Tool	6
034-405	Controlled Release Fence Stretcher	6
034-415	Hired Hand Fence Stretcher Tool	6

### Trailer Hitch Couplers & Balls

Meets SAE Standards

Part No.	SAE Class	Ball Size	Std. Pkg.
034-981P-1	2	2"	6
034-985P-1	3	3"	6



Part No	SAE Class	Ball Size	Shank	Finish	Std. Pkg.
034-6391	3	2"	1" x 2"	Chrome	6
034-6393	4	2-5/16"	1" x 2"	Chrome	6



### Brake Winches

- Permanently lubricated bearings
- Ergonomic grip handle
- Zinc tuffplate finish



034-B2500



034-DLB1500A



034-DL900A



034-DLB2500A

Part No.	Description	Std. Pkg.
034-B2500	B Series Brake Winch, 2500 Lb.	3
034-DLB1500A	DLB Series Brake Winch, 1500 Lb.	4
034-DLB2500A	DLB Series Brake Winch, 2500 Lb.	4
034-DL900A	DL Series Series Pull Winch, 900 Lb.	6



A Dependable Company Since 1886

**DUTTON-LAINSON COMPANY**

## Suction Gun

- Develops powerful suction for removing old grease and oil from differentials
- Rear axle housings and oil filters
- 3/4 pint capacity
- Powder coated copper bronze finish
- 10 inch flex nozzle



Part No.	Description	Std. Pkg.
034-350	Suction Gun with 10" Flex Nozzle	12 Ea.

## AG-Industrial Jacks

- Swivel Ag-Industrial Jack
- Top Wind with 10 inch travel
- Includes weld-on bracket and snap ring
- 2000 lb. capacity



Part No.	Description	Std. Pkg.
034-6631	Top Wind Ag Jack, 10"	1 Ea.

- Includes support bracket for added stability
- Jack can be welded or bolted to standard A-frame couplers
- Powder coated black finish
- Removable wheel or foot sold separately



Part No.	Description	Std. Pkg.
034-6670B	A-Frame Jack, 2000 Lb. Capacity	1 Ea.

## Winches

### Pulling Winch

- 1800 Lb. winch for horizontal pulling applications
- High carbon steel gears
- Permanently lubricated bearings
- Reversible ratchet
- Ergonomic grip handle
- Tuffplate finish
- Handle included



Part No.	Description	Std. Pkg.
034-DL1802A	Pulling Winch, 1800 Lb. Capacity	4 Ea.

### Worm Gear Winches

- 1500 lb. worm gear winch with regular drum and handle drive
- Reel automatically stops turning whenever cranking is stopped, locking load in place
- Powder-coated bronze finish
- Permanently lubricated bearings
- Handle included



034-WG1500



- 2000 lb. worm gear winch with split drum, allowing cable to pull from opposite directions
- Reel automatically stops turning whenever cranking is stopped, locking load in place
- Powder-coated bronze finish
- Permanently lubricated bearings
- Handle included



034-WG2000



Part No.	Description	Std. Pkg.
034-WG1500	Worm Gear Winch, 1500 Lb. Capacity	4 Ea.
034-WG2000	Worm Gear Winch, Split, 2000 Lb. Capacity	4 Ea.

## GOLIGHT®

### Remote Controlled Lights

**Powerful** - From stormy roadside emergencies at 2 a.m., to rainy late-night repairs, to moonless nights on the water. Power is our first priority in lighting.

**Versatile** - The painted Golight® designs reflect thousands of uses and applications for portable lighting. Our foremost concern is designing units that adapt to any real-world situation. That's why all of our units combine a unique 360° rotation with 135° tilt, creating a sphere of coverage that reaches the most extreme angles.

**Golight® Cr5 Pentabeam™** - Combining a revolutionary five-sided parabolic reflector with an axial filament. Philips® bulb, Cr5 Pentabeam™ technology generates an extremely bright, virtually perfect beam of light to eliminate dark spots cast a broad spectral pattern and reach distances of up to one-half mile.

#### Golight® Radioray® Mount

- White wireless remote control handheld spotlight effective to 150 feet
- 12 inch stanchion mount with 2 port Perko female receptacle for power
- 360 degrees motorized rotation and 140 degrees motorized tilt
- Includes red/green running lights
- 65 watt bulb pulls 5.5 amps and produces 5 million adjusted retail candlepower and 400,000 initial candlepower



Part No.	Description	Std. Pkg.
151-2100	Golight® Radioray® Wireless Remote Control Spotlight-stanchion Mount	1 Ea.

#### Radioray® Remote Controlled Spotlights

- Remote controlled operation
- 400,000 Candlepower
- 5.5 AMPS
- UV ray and saltwater resistent

151-7901



Part No.	Description	Std. Pkg.
151-7901	Radioray® White Remote Controlled Spotlight	6 Ea.

### Remote Controlled Lights (Cont.)

#### Radioray® Remote Controlled Spotlights (Cont.)

- Programmable wireless remote
- Suction cup & magnet mount shoe
- 15' cord w / cigarette plug for 12v DC

151-7951



Part No.	Description	Std. Pkg.
151-7951	Radioray® Black Remote Controlled Spotlight	6 Ea.



### Electric Fuel Pumps



#### 115 Volt

This pump is built with a 1/3 horsepower motor and designed for high performance. The **M-3120** is the pump of choice for heavy equipment applications.

- Use for fixed locations with low viscosity petroleum fuels
- Available with either manual or automatic nozzle
- Comes with 12 feet of 3/4 inch UL grounded hose
- Pump and motor UL Listed to U.S. and Canadian standards
- Includes check valve with pressure relief function
- External switch coverplate removes easily for access to switch. Motor and UL listing remain intact

Part No.	Description	Std. Pkg.
060-M-3120-ML	High Performance 115 Volt Pump	1



## Electric Fuel Pumps (Cont.)

### 115 Volt

This version of our popular gear pump is the **M-11155**. Designed for stationary locations, the **M-1115** offers a 30-minute duty cycle from a permanent magnet motor. The pump's basic gear design has been proven over the years in demanding agricultural fleet and light industrial applications. Reliability and ease of maintenance are the hallmarks of this versatile performer.



- Available with either an automatic or manual nozzle
- Comes with 12 feet of 3/4 inch UL grounded hose
- Convenient spin collar for easy installation
- Overload protected motor and thermal breaker
- UL listed system and CSA certified

Part No.	Description	Std. Pkg.
060-M-1115S-MU	Gear Pump 115 Volt	1

The **M-150S-MU** is a 12 volt pump with proven dependability and efficiency, it is considered one of the best electric fuel pumps on the market.

- UL listed motor and CSA certified
- Over load protected motor
- Convenient spin collar for easy installation
- Comes w / 12 ft. of 3/4" grounded hose adjustable suction pipe
- Power cord 15 ft. x 12/2 AWG
- Manual nozzle
- Use w / gasoline (alcohol blends E15), diesel fuel (biodiesel blends B20), and kerosene



060-M-150S-MU

Part No.	Description	Std. Pkg.
060-M-150S-MU	12 Volt, Electric Fuel Pump, 15 GPM	1

## Hand Pumps

The **BP-12** lever handle barrel pump has durable steel construction and an adjustable lever pivot for heavy liquids.



060-BP-12

- NPT or buttress threads
- 2" connections
- 2/4" metal spout and telescoping suction pipe included

Part No.	Description	Std. Pkg.
060-BP-12	Lever Pump with Adjustable Pivot	1

The **HP-100-UL Dual Flo®** is a premium hand pump that is reliable and versatile. Use for high-volume fuel transfer or easier pumping for heavier fluids. The **HP-100-UL** generates twice the flow of any other hand pump.

- Delivers up to 50 gal. per 100 strokes
- Lightweight corrosion-resistant aluminum construction
- Complete ready to install
- Comes w / 8 ft. of 3/4" hose
- Built-in anti-siphon valve
- Use w / gasoline (alcohol blends E15), diesel fuel (biodiesel blends B20), and kerosene



060-HP-100-NUL

The **RP-10-UL** rotary hand pump is rugged simplicity in action, with extra efficiencies in field transfer of gasoline and up to medium weight oils. The perfect pump where maximum productivity and maximum portability are important.

- 10 gallons per 100 revolutions
- Strainer and anti-siphon valve built in
- Lightweight, extremely durable aluminum housing to resist scratches and corrosion
- Comes w / 8 ft. or 3/4" hose



060-RP-10-UL

Part No.	Description	Std. Pkg.
060-HP-100-NUL	Dual Flo Premium Hand Pump	1
060-RP-10-UL	Rotary Hand Pump	1

# Oilfield Supplies

122



## Nozzles

- Automatic diesel nozzle
- 1 in. NPT
- UL listed
- With curved spout for M-3025 & M-3130 pump

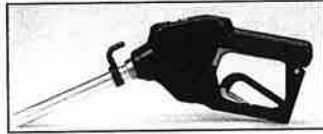

060-906005-1

Part No.	Description	Std. Pkg.
060-906005-1	Automatic Diesel Nozzle	1

## Digital Fuel Meter

- Aluminum construction
- Reads in gallons
- Flow rate 3-30 GPM



060-113255-1

Part No.	Description	Std. Pkg.
060-113255-1	Digital Fuel Meter	1

## Mechanical Fuel Meter

- Filter for gallons with 3/4 inch NPT inlet/outlet
- UL listed
- 4 to 20 GPM (15 to 75 LPM)
- 3-digit display
- 50 PSIG / 3.4 bar



060-FM-100-G6N

Part No.	Description	Std. Pkg.
060-FM-100-G6N	Mechanical Fuel Meter	1



## Syphon Spray Gun

- 12" extension tube
- Adjustable nozzle tip controls flow and spray pattern
- 6 ft. PVC feed tube with brass sinker



Part No.	Description	Std. Pkg.
200-79SG012	Syphon Spray Gun	1

## Protective Safety Air Guns

### Safety Air Guns

- Focused brass nozzle
- Meets or exceeds OSHA standards



200-745

- Focused brass nozzle
- Precision volume control
- Meets or exceeds OSHA standards



200-74SK

Part No.	Description	Std. Pkg.
200-745	Jet Guard Safety Air Gun	1
200-74SK	Jet Guard Safety Air Gun	1

### Extended Reach Safety Air Guns

Safety, power and durability built into every extended reach model.

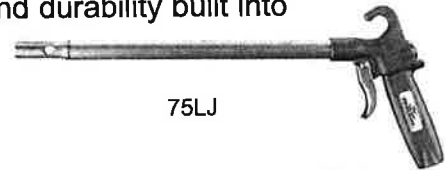

75LJ

Part No.	Description	Std. Pkg.
200-75LJ012AA	Long John Safety Air Gun w/ 12" Extension	1
200-75LJ024AA	Long John Safety Air Gun w/ 24" Extension	1
200-75LJ036AA	Long John Safety Air Gun w/ 36" Extension	1
200-75LJ048AA	Long John Safety Air Gun w/ 48" Extension	1
200-75LJ060AA	Long John Safety Air Gun w/ 60" Extension	1

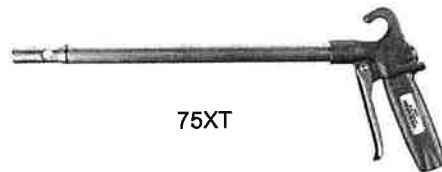

75XT

Part No.	Description	Std. Pkg.
200-75XT036AA	Xtra Thrust Safety Air Gun w/ 36" Extension	1
200-75XT048AA	Xtra Thrust Safety Air Gun w/ 48" Extension	1

## Protective Air Shield

### Compact, Thumb Actuated Safety Air Gun

- Cushioned actuator
- Convenient hanging hook
- Meets or exceeds OSHA standards



200-970

Part No.	Description	Std. Pkg.
200-970	Thumb Actuated Safety Air Gun, Compact	1



## GUNNEBO JOHNSON CORPORATION

### Snatch Blocks

#### Single Sheave Snatch Blocks

- Rugged and reliable
- Easy-open side plates
- 4 to 1 design factor
- Metric rated
- Large hand nuts
- Retainer on latch pin
- Anchor shackle with retainer pin
- Bronze bushing

Single Sheave w/Hook & Optional Latch



SWIVEL HOOK		SWIVEL HOOK W/LATCH		W.L.L. (METRIC TON)		Description
Part No.	Wt. (Lbs.)	Part No.	Wt. (Lbs.)	SHV OD	Wire Rope (IN)	
<b>2 MT</b>						
181-474498	5	181-475092	5	3	5/16 - 3/8	SB 2S 3B H
<b>4 MT</b>						
181-474492	14	181-474655	15	4	3/8 - 1/2	SB 4S 4B H
181-474668	14	181-475089	15	4	3/8 - 1/2	SB 4S 4R H
181-474619	19	181-475090	19	6	3/8 - 1/2	SB 4S 6B H
181-474671	19	181-475091	19	6	3/8 - 1/2	SB 4S 6R H
181-474622	24	181-475093	25	8	3/8 - 1/2	SB 4S 8B H
181-474676	24	181-475094	25	8	3/8 - 1/2	SB 4S 8R H
181-474654	33	181-475095	33	10	3/8 - 1/2	SB 4S 10B H
181-475057	33	181-475096	34	10	3/8 - 1/2	SB 4S 10R H
181-474816	40	181-475097	40	12	3/8 - 1/2	SB 4S 12B H
181-475058	42	181-475098	43	12	3/8 - 1/2	SB 4S 12R H
181-474817	49	181-475099	50	14	3/8 - 1/2	SB 4S 14B H
181-475059	51	181-475100	52	14	3/8 - 1/2	SB 4S 14R H
<b>8 MT</b>						
181-474361	27	181-475101	27	6	5/8 - 3/4	SB 8S 6B H
181-474362	30	181-475102	30	6	5/8 - 3/4	SB 8S 6R H
181-474367	35	181-474601	35	8	5/8 - 3/4	SB 8S 8B H
181-474993	34	181-475103	35	8	5/8 - 3/4	SB 8S 8R H
181-474373	41	181-475104	41	10	5/8 - 3/4	SB 8S 10B H
181-474994	40	181-475105	41	10	5/8 - 3/4	SB 8S 10R H
181-474379	52	181-474583	53	12	5/8 - 3/4	SB 8S 12B H
181-474995	55	181-475106	55	12	5/8 - 3/4	SB 8S 12R H
181-474385	64	181-475107	64	14	5/8 - 3/4	SB 8S 14B H
181-474996	64	181-475108	65	14	5/8 - 3/4	SB 8S 14R H

#### Single Sheave Snatch Blocks (Cont.)



Single Sheave W/Shackle



Single Sheave Tailboard

Swivel Shackle			Tailboard (No Fitting)		
Part No.	Description	Wt. Lbs.	Part No.	Description	Wt. Lbs.
<b>2 MT</b>					
181-474602	SB 2S 3B S	5	181-474572	SB 2S 3B T	3
<b>4 MT</b>					
181-474603	SB 4S 4B S	16	181-474562	SB 4S 4B T	9
181-474554	SB 4S 4R S	16	181-474990	SB 4S 4R T	9
181-474620	SB 4S 6B S	21	181-474621	SB 4S 6B T	14
181-474670	SB 4S 6R S	21	181-474991	SB 4S 6R T	14
181-474623	SB 4S 8B S	26	181-474624	SB 4S 8B T	19
181-474673	SB 4S 8R S	26	181-474992	SB 4S 8R T	19
181-474644	SB 4S 10B S	35	181-474720	SB 4S 10B T	27
181-475060	SB 4S 10R S	35	181-475063	SB 4S 10R T	25
181-474719	SB 4S 12B S	42	181-474721	SB 4S 12B T	34
181-475061	SB 4S 12R S	44	181-475064	SB 4S 12R T	36
181-474660	SB 4S 14B S	51	181-474722	SB 4S 14B T	43
181-475062	SB 4S 14R S	53	181-475065	SB 4S 14R T	45
<b>8 MT</b>					
181-474365	SB 8S 6B S	29	181-474542	SB 8S 6B T	17
181-474366	SB 8S 6R S	32	181-474998	SB 8S 6R T	20
181-474371	SB 8S 8B S	37	181-474369	SB 8S 8B T	25
181-474372	SB 8S 8R S	36	181-474999	SB 8S 8R T	14
181-474377	SB 8S 10B S	43	181-474375	SB 8S 10B T	31
181-474378	SB 8S 10R S	42	181-475000	SB 8S 10R T	30
181-474587	SB 8S 12B S	54	181-474381	SB 8S 12B T	34
181-474997	SB 8S 12R S	57	181-475001	SB 8S 12R T	45
181-474667	SB 8S 14B S	66	181-474679	SB 8S 14B T	54
181-474664	SB 8S 14R S	66	181-475002	SB 8S 14R T	54

#### Derrick Snatch Blocks

- 4 to 12 metric tons W.L.L.
- Standard galvanized finish
- Handling slots in the body
- Large knock-off handles
- Interlocking internal design
- For lifting materials
- R-pin retainers



Part No.	Wt. Lbs.	WLL	Description	Wire Rope	Sheave Dia.
181-687710016	33	4T	MHSB4S8TS	3/8 - 1/2	8"
181-687334	83	12T	MHSB12S10TS	1/2 - 9/16	10"
181-687853	122	12T	MHSB12S14TS	5/8 - 3/4	14"



# Oilfield Supplies

## **GUNNEBO JOHNSON** CORPORATION

### Oil Field Blocks

#### Guyline Blocks

- Metric rated
- 3 to 1 design factor
- Available in both single and double sheave



#### Single Sheave

Part No.	Wt. Lbs.	Description	Std. Rope (in.)
181-475538016	25	GL 5S6	1/2
181-475540020	25	GL 7.5S6	5/8

#### Double Sheave

Part No.	Wt. Lbs.	Description	Std. Rope (in.)
181-475539016	45	GL 10D6	1/2
181-475541020	42	GL 15D6	5/8

#### Hay Fork Pulley

- US tons
- Light weight
- Rugged and reliable
- 3.3 to 1 design factor
- Bronze bushing and roller bearing models



#### Eye Fitting

Part No.	Wt. Lbs.	Description	Std. Rope (in.)
181-453865	7	HF1S4BE-MR	1 - 1-1/4
181-453869	7	HF1S4RE-MR	1 - 1-1/4
181-453866	8	HF1S4BE-WR	3/8 - 1/2
181-453870	7	HF1S4RE-WR	3/8 - 1/2

#### Hook Fitting

Part No.	Wt. Lbs.	Description	Std. Rope (in.)
181-453867	7	HF1S4BH-MR	1 - 1-1/4
181-453871	7	HF1S4RH-MR	1 - 1-1/4
181-453868	8	HF1S4BH-WR	3/8 - 1/2
181-453872	7	HF1S4RH-WR	3/8 - 1/2

### Oil Field Blocks (Cont.)

#### Tong Line Blocks

- Metric rated
- Easy open side plate
- 4 to 1 design factor
- Bronze bushing and roller bearing models



With Swivel Eye			W.L.L. (Metric Ton)	
Part No.	Wt. Lbs.	Description	Wire Rope In.	SHV OD
<b>2.8 MT</b>				
181-474804	15	TL 2.8S 6B E	1/2 - 5/8	6
181-474805	15	TL 2.8S 6R E	1/2 - 5/8	6
181-474806	21	TL 2.8S 8B E	1/2 - 5/8	8
181-474807	22	TL 2.8S 8R E	1/2 - 5/8	8
181-474808	29	TL 2.8S 10B E	1/2 - 5/8	10
181-474809	28	TL 2.8S 10R E	1/2 - 5/8	10
181-474810	37	TL 2.8S 12B E	1/2 - 5/8	12
181-474811	40	TL 2.8S 12R E	1/2 - 5/8	12

#### Laydown Blocks

- Metric rated
- Easy open side plate
- 4 to 1 design factor
- Bronze bushing and roller bearing models



With Swivel Eye & Hook			W.L.L. (Metric Ton)	
Part No.	Wt. Lbs.	Description	Wire Rope In.	SHV OD
<b>1 MT</b>				
181-474812	21	LD 1S 6B H	1/2 - 5/8	6
181-474813	21	LD 1S 6R H	1/2 - 5/8	6
181-474814	28	LD 1S 8B H	1/2 - 5/8	8
181-474815	27	LD 1S 8R H	1/2 - 5/8	8



## HAWK SOLUTIONS

### Gas & Air Leak Detection

Find large and small leaks quickly with this safe to use liquid. Not a soap! But a scientifically blended product that has the ability to find even the smallest hairline leaks and indicate them with a cluster of bubbles. Simply spray on, bush on, squirt on or swab on and presto, large leaks - large bubbles, small leaks - small bubbles. No hard chemical, safe to use, contains no ammonia's, acids, or any other harsh ingredients.



- Works in 3 to 5 seconds
- Simple to use
- Apply and bubbles will appear where leaks present
- Exception seeping qualities
- Locates the very small leaks quickly and accurately

Part No.	Description	Std. Pkg.
191-0200	Hawk 8 Oz. Gas & Air Leak	24 Ea.
191-4144	Hawk 1 Gal. Gas & Air Leak	4 Gal.
191-3240	Hawk 5 Gal. Gas & Air Leak	1 Ea.



### All-Cast Jacks

**Hi-Lift All-Cast** jacks are the only all-cast jacks manufactured in the world today.

- Powdered-coated finish, high quality, durable finish with zinc-plated hardware
- Tested accordance with ASME/ANSI B30,1992
- Rated load capacity - 4660 lbs. (2114 kg)
- Tested load capacity - 7000 lb. (317 kg), achieving a 150% safety factor
- Winching capacity - 5000 lb.
- Clamping capacity - 750 lb. 072-HL-485
- Height - 48"
- Weight - 28.16 lb.

**Hi-Lift Cast & Steel** jacks are exactly the same as the all-cast except that they have 4 stamped high-strength steel parts. The result is the same rigorous quality standards but with a lower price.

072-HL-484



Part No.	Description	Std. Pkg.
072-HL-484	48", Cast & Steel Jack	1
072-HL-485	48", All-Cast Jack	1



### Sample Bags



Part No.	Description	Std. Pkg.
047-4-1/2x6	4-1/2" x 6" Sample Bags	100
047-5-1/2x10-1/2	5-1/2" x 10-1/2" Sample Bags	100
047-5x7	5" x 7" Sample Bags	100
047-5x7 Poly	5" x 7" Polyliner	100



## Gator Grip Gloves

### GGT5® Series



- Oil-gas operations
- Handling high-viscosity fluids
- Frac gels
- Friction reducers
- Grease

Part No.	Description	Std. Pkg.
205-4020-S	Gator Grip GGT5 Glove Cut 5	1 Pr.
205-4020-M	Gator Grip GGT5 Glove Cut 5	1 Pr.
205-4020-L	Gator Grip GGT5 Glove Cut 5	1 Pr.
205-4020-XL	Gator Grip GGT5 Glove Cut 5	1 Pr.
205-4020-XXL	Gator Grip GGT5 Glove Cut 5	1 Pr.

### Mud GGT5® Series



- Oil-gas operations
- Diesel fuel
- Honey oil
- Hydraulic fluid
- Friction reducers

Part No.	Description	Std. Pkg.
205-4021X-S	Gator Grip Mud Glove GGT5 Cut 5	1 Pr.
205-4021X-M	Gator Grip Mud Glove GGT5 Cut 5	1 Pr.
205-4021X-L	Gator Grip Mud Glove GGT5 Cut 5	1 Pr.
205-4021X-XL	Gator Grip Mud Glove GGT5 Cut 5	1 Pr.
205-4021X-XXL	Gator Grip Mud Glove GGT5 Cut 5	1 Pr.

## Mechanics' Style Gloves

### Chrome Series Cut 5



- General work
- Maintenance and mechanics'

Part No.	Description	Std. Pkg.
205-4022-S	Chrome Series Mechanics Glove Cut 5	1 Pr.
205-4022-M	Chrome Series Mechanics Glove Cut 5	1 Pr.
205-4022-L	Chrome Series Mechanics Glove Cut 5	1 Pr.
205-4022-XL	Chrome Series Mechanics Glove Cut 5	1 Pr.
205-4022-XXL	Chrome Series Mechanics Glove Cut 5	1 Pr.

## Mechanics' Style Gloves (Cont.)

### Chrome Series Cut 5 Impact Hi-Vis



- Maintenance (mechanic, facility)
- Oil-gas operations: rig work, facility maintenance, pipe/tool handling
- Extrication/rescue

Part No.	Description	Std. Pkg.
205-4026-S	Chrome Series Impact Hi-Vis Glove Cut 5	1 Pr.
205-4026-M	Chrome Series Impact Hi-Vis Glove Cut 5	1 Pr.
205-4026-L	Chrome Series Impact Hi-Vis Glove Cut 5	1 Pr.
205-4026-XL	Chrome Series Impact Hi-Vis Glove Cut 5	1 Pr.
205-4026-XXL	Chrome Series Impact Hi-Vis Glove Cut 5	1 Pr.

### Chrome Series Cut 5 Impact Slipfit™



- Maintenance (mechanic, facility)
- Oil-gas operations: rig work, facility maintenance, pipe/tool handling
- Extrication/rescue

Part No.	Description	Std. Pkg.
205-4028-S	Chrome Series Impact Glove Fast Fit Cut 5	1 Pr.
205-4028-M	Chrome Series Impact Glove Fast Fit Cut 5	1 Pr.
205-4028-L	Chrome Series Impact Glove Fast Fit Cut 5	1 Pr.
205-4028-XL	Chrome Series Impact Glove Fast Fit Cut 5	1 Pr.
205-4028-XXL	Chrome Series Impact Glove Fast Fit Cut 5	1 Pr.

### Chrome Series Cut 5 Impact



- Palm cut-resistance
- Back of hand impact protection
- PVC printed palm grip
- Padded palm

Part No.	Description	Std. Pkg.
205-4024-M	Chrome Series Med. Impact Glove Cut 5	1 Pr.
205-4024-L	Chrome Series Lrg. Impact Glove Cut 5	1 Pr.
205-4024-XL	Chrome Series XL Impact Glove Cut 5	1 Pr.







## Torch Kits

The Big and Little Max are the only propane torches with a molded handle, which is our registered trademark, for better control and comfort. No other propane torch can have this handle. The Little Max comes with everything you need for small projects, except the tank.



194-500G



194-50G



- Burns brush and kills weeds
- Charcoal starter
- Removes parking lot markings
- Thaws frozen pipes
- Thaws out equipment
- Heat metals and branding irons
- Melts Tar/Asphalt
- Melts snow and ice
- Railway maintenance
- Paint removal

Part No.	Description	Std. Pkg.
194-500G	Hot Max Torches, Big Max 500,000 BTU Propane Torch Kit	6 Ea.
194-50G	Hot Max Torches, Little Max 50,000 BTU Propane Torch Kit	6 Ea.



America's favorite brand Hyde® Tools is North America's most respected resource for surface preparation and finishing hand tools. More professionals prefer Hyde® Tools than any other brand.

## Black & Silver® Tools

The Black & Silver® putty knives are made with high carbon steel blades. They're individually ground, polished, mirror finished, and clear coated, with a corrosion resistant surface.

### Putty Knives



082-02000



082-07010

### Scrapers



082-02400



082-07410



082-02350

## Black & Silver

Part No.	Description	Std. Pkg.
082-02000	1-1/4" (32mm), Flexible Putty Knife	5
082-02050	1-1/4" (32mm), Stiff Putty Knife	5
082-02100	1-1/2" (38mm), Flexible Putty Knife	5
082-02150	1-1/2" (38mm), Stiff Putty Knife	5
082-02250	2" (51mm), Flexible Putty Knife	5
082-02300	2" (51mm), Stiff Putty Knife	5
082-02350	3" (76mm), Flexible Scraper	5
082-02400	3" (76mm) Stiff Chisel Edge Scraper	5

## Hardwood Handles

Part No.	Description	Std. Pkg.
082-07010	1-1/4" (32mm), Flexible Putty Knife	5
082-07060	1-1/4" (32mm), Stiff Putty Knife	5
082-07210	1-1/4" (38mm), Xtra HD Stiff Putty Knife	5
082-07410	3" (76mm) Stiff Chisel Scraper	5



## Joint Knives



082-02570



082-07360



082-02750

## Black & Silver

Part No.	Description	Std. Pkg.
082-02355	3" (76mm), Flex, Joint Knife w/Hammer Head	5
082-02570	4" (102mm), Flex, Joint Knife w/Hammer Head	5
082-02550	4" (102mm), Flexible Joint Knife	5
082-02750	5" (127mm), Flexible Joint Knife	5
082-02850	6" (152mm), Flexible Joint Knife	5
082-02852	6" (152mm), Super Flex™ Joint Knife	5

## Hardwood Handles

Part No.	Description	Std. Pkg.
082-07360	3" (76mm), Flexible Joint Knife	5
082-07745	4" (102mm), Flexible Joint Knife	5
082-07760	5" (127mm), Flexible Joint Knife	5
082-07860	6" (152mm), Flexible Joint Knife	5

## All-In-One Tool

### PRO Wood™ Handle 5-In-1 Tool

- Scrape paint
- Remove putty
- Open cracks
- Spread Compound
- Use on curved surfaces



082-07975

Part No.	Description	Std. Pkg.
082-07975	2-1/2" (64mm), High Carbon Steel 5-IN-1 Tool, Pro Wood Handel	5

## Glass Scraper

### Delta™ Heavy Duty Glass Scraper

Extra firm clamp holds blade under scraping pressure, built-in sash guide (1/16") maintains paint/glass seal. Blade track that minimizes clogging and longer handle to keep hands away from the blade. Blade is held at 5° offset to get under paint for improved scraping. Accepts standard single-edge blades.



082-13010



082-13145



082-13125

Part No.	Description	Std. Pkg.
082-13010	Delta HD Glass Scraper (Scraper Only)	20
082-13125	100 Single Edge Blades	10
082-13145	10 Blade Dispenser	10

## Utility Knives

### Top Slide Utility Knife

- 3 Blade positions
- Zinc alloy texture finish
- 1 Heavy duty blade
- Overlap nose for cutting strength



082-42070



082-42100



082-42101

Part No.	Description	Std. Pkg.
082-42070	Top Slide Utility Knife w/1 Blade	5
082-42100	5 - Heavy Duty .025 Blades	10
082-42101	100 Blade Dispenser	1



## Flooring Knives

### Shot Point Flooring Knife

- Cut floor covering and drywall material
- High carbon cutlery steel blade
- Hardened, tempered and honed
- Hardwood handle



### Long Point Vinyl Knife

- Cut soft and hard core vinyl and floor covering
- High carbon cutlery steel blade
- Hardened, tempered and honed
- Hardwood handle



Part No.	Description	Std. Pkg.
082-20250	2-1/2" (64mm) Short Point Flooring Knife	5
082-20450	2-1/2" (64mm) Long Point Vinyl Knife	5

## Pull Scrapers

Well balanced solid polypropylene handle with pull knob grip and nail setting surface gives extra leverage. Keeps knuckles safely away from work surface. It has multiple scraping edges. Four edge blades have 2 rough and 2 smooth edges.



- 4 edge scraping blade
- 2-1/2" (64mm) diameter
- Handle length: 12-1/2"

Part No.	Description	Std. Pkg.
082-10540	Pull Scraper w/Pull-Knob, 2-1/2"	5
082-11130	Replacement Scraper Blades	10

## Caulk Gun

- For use with all 9 inch cartridges
- Red powder coated steel frame resists corrosion
- Smooth, round compression rod
- Quick release thumb lever



Part No.	Description	Std. Pkg.
082-46400	Caulking Gun, Smooth Rod Style	12



Rugged, durable Igloo industrial strength water coolers keep water cold, clean and available. Available in 2, 5 and 10 gallon capacities to meet the needs of any size job.

- HDPE exterior won't chip, peel, buckle or rust
- Large grip lid handle for easy opening even with gloves
- Ultratherm® insulation for maximum cold retention
- UV stabilizers prevent fading, cracking
- White FDA food-grade inner liner is easy to clean and resists stains and odors
- Wide mouth pressure fit lid for easy filling
- Keeper cord prevents lid loss
- Reinforced handles and cup dispenser bracket
- "Drinking Water" imprint meets OSHA requirements
- All parts are replaceable for extended life



Part No.	Description	Std. Pkg.
143-24009	Replacement Spigot	10 Ea.
143-25041	Wire Rack for 2-5 Gallon	1 Ea.
143-4101	10 Gallon, 400 Series	1 Ea.
143-421	2 Gallon, 400 Series	1 Ea.
143-431	3 Gallon, 400 Series	1 Ea.
143-451	5 Gallon, 400 Series	1 Ea.





## Tube Cutters

**II-Duty Tube Cutter** for 1/8" to 1-1/8" (4mm to 28mm) O.D. tubing Imperial's unique design eliminates spiraling for clean right angle cuts. Our high precision machining and construction method permits one-piece screw type axle for easy access to cutting wheel-no clip to lose or replace rugged nickel chrome plated aluminum alloy body includes: (2) S75015 general purpose cutter wheels. Length: 5", wt. 6.5 oz.

### Hard Metal



048-TC-1010

- 1/8" to 1-1/8" (4mm to 28mm) O.D. tubing
- Includes (2) S75046 cutter wheels for continuous cutting of stainless steel, monel and other hard-temper tubing
- Length 5", wt. 8.8 oz.

### General Purpose



048-TC-1000

- 1/8" to 1-1/8" (4mm to 28mm) O.D. tubing
- Includes (2) S75015 general-purpose cutter wheels
- Length 5", wt. 8.8 oz.

Part No.	Description	Std. Pkg.
048-TC-1010	Hard Metal Tube Cutter, 5" Long	1
048-TC-1000	General Purpose Tube Cutter, 5" Long	1

## Replacement Tube Cutter Wheels

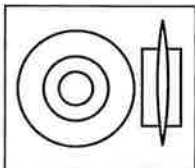

048-S75075

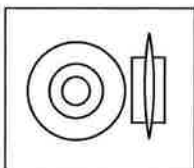

048-S75046

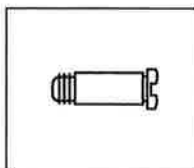

048-S74762

Part No.	Description	Std. Pkg.
048-S75075	General Purpose Cutter Wheel	10
048-S75046	Cutter Wheel for Stainless Steel	5
048-S74762	Cutter Wheel for Retaining Screw	5

## Tube Cutters (Cont.)

**IMP Mini Tube Cutter** for 1/8" to 5/8" (4mm to 15mm) O.D. Tubing.

- Big capacity, small size tube cutters
- Corrosion resistant stainless steel rollers for easier cutter engagement on tubing
- Swing radius: 1-1/4"
- Length: 1-3/4", wt. 2.5 oz.
- Includes: (1) S32633 cutter wheel



048-TC-1050

Part No.	Description	Std. Pkg.
048-TC-1050	IMP Mini Tube Cutter, 1-3/4" Long	1

**Plastic Tube and Hose Shears** for 1/16" to 1/2" (1mm to 13mm) O.D. plastic tubing and non-metal reinforced hose.

- Compact shear is spring loaded
- Includes S8115601 replaceable
- Hardened steel blade
- Length: 2-7/8", wt. 1.0 oz.



048-307-FP

Part No.	Description	Std. Pkg.
048-307-FP	Plastic Tube and Hose Shears	1

## Tube Benders

**364-FHA Lever Type Tube Benders** for 1/4" to 1/2" O.D. tubing. Makes smooth, tight radius bends up to 180° with minimum effort. No scoring or flattening or tubing. Calibrated to show angle of bend. Wide hook grips tubing securely.



Part No.	Description	Std. Pkg.
048-364-FHB-04	1/4" O.D. Tube	1
048-364-FHA-05	5/16" O.D. Tube	1
048-364-FHB-06	3/8" O.D. Tube	1
048-364-FHB-08	1/2" O.D. Tube	1
048-364-FHA-12	3/4" O.D. Tube	1



## Tube Benders (Cont.)

### Triple Head Tube Benders

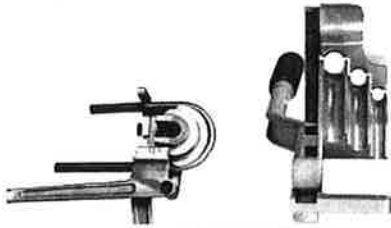

Part No.	Description	Std. Pkg.
048-470-FH	1 1/16", 3/8", and 1-1/2"	1
048-370-FH	1/4", 3/8", and 1/2"	1

## Heavy Duty Tube Benders

### Lever Type Heavy Duty Tube Benders

**664-FH Heavy-Duty 180° Tube Bender** with Roto-Lock™ indexing handle makes tight bends for 1/4" to 1/2" O.D. tubing.

- New design for accurate and tight bends up to 180° in steel and other tough metals
- Patented, quick action trigger release repositions two-stage handle midway through a bend when both handles begin to meet. This feature allows easy fabrication of optimized bends up to 180° with reduced effort, better control and no crossing of handles!
- Rollers in bending handle reduced friction and bending effort; eliminate scoring of tubing
- Comfortable and durable ergonomically molded cushion grips
- Vise lug for mounting in vise
- Clamshell packaging available for 1/4" and 3/8" O.D. models



Part No.	Tube O.D. (in)	Radius to Center of Tube (in)	Weight (lbs)
048-664-FH-04	1/4"	9/16"	1.2
048-664-FH-06	3/8"	15/16"	3.7
048-664-FH-08	1/2"	1-1/2"	7.6

**564-FH and 564-FHT Lever Type Heavy-Duty Tube Bender** for 3/8" and 1/2" O.D. tubing. These heavy-duty tube benders feature high-strength tool steel construction on all components subjected to stress during the bending process - including forming rollers, form wheel, stop pins, hook and cam adjustment shaft. Unique offset handle design assures maximum power transfer between worker and bender. Bender will not "gyrate" as handles are brought to closed position.

- Meets ANSIB31.1/ASME Sec. 3 boiler/power requirements (FH models only)
- Vise mountable
- Prevents slippage and flattening
- Fully adjustable to compensate for variances in tube tolerance
- Starts with handles at 90° angle
- Built for rugged day-in and day-out use
- Precise bends
- Self-aligning rollers eliminate scoring and reduce bending effort



Part No.	Tube O.D. (in)	Radius to Center of Tube (in)	Weight (lbs)
048-564-FH-06	3/8"	1-1/8"	5.5
048-564-FH-08	1/2"	1-1/2"	7.0

## 45° Flaring Tools

For 3/16", 1/4", 5/16", 3/8", 7/16", 1/2" and 5/8" O.D. tubing. Flares 7 sizes of tubing. Rugged forged steel slip-on yoke and hardened flaring bar. Positive clamping action of bars prevents tube slippage. Self centering yoke w/swivel-type, hardened steel, chrome-finished flaring cone forms better flares with less effort. Satin finish nickel-chrome plated.

- Soft tubing only
- Copper, aluminum, brass

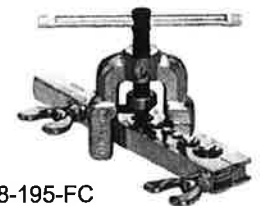

Part No.	Description	Std. Pkg.
048-195-FC	45° Flaring Tool for Soft Tubing	1



## Cutting and Flaring Kit

- Tube cutter: TC-1000
- Flaring tool: 195-FC (45°)
- O.D. tube (inch): 3/16", 1/4", 5/16", 3/8", 7/16", 1/2" and 5/8"
- Tool case included

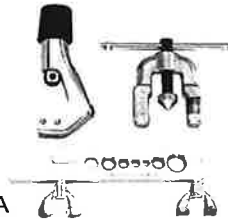

048-1226-FA

Part No.	Description	Std. Pkg.
048-1226-FA	Cutting and Flaring Kit	1

## Service Manifolds

### 400 Series Deluxe 2-Valve Brass Manifold

- Dual O-Ring Valves - Precision engineered with dynamic full-flow design for faster trouble-free evacuation and charging
- Precision Gauges & Protection Boots - Unique design with easy to read color-coded scales provides superior resistance to shock, vibration and pulsation for superior performance and extended gauge life
- Soft-Seat Valves - Precision engineered with dynamic full-flow dual o-ring valve design for fast trouble-free evacuation and charging, seat tightly with fingertip pressure
- PolarShield™ Hi-Performance Hoses - 800 PSI working pressure, 4,000 PSI burst pressure - not all models include hose
- Ergonomic Handles - Durable, soft-touch non-slip surface, even with oily fingers
- Swivel Hanger

Non-flutter gauges with high-visibility faceplates

Gauge boots are standard on 400 to 500 Series

Needle valve design with full-flow porting

Larger knobs with soft-touch grip surface

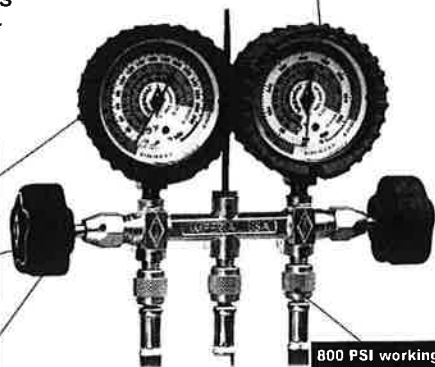

800 PSI working and 4,000 PSI burst pressure hoses

Part No.	Refrigerant	Manifold Port
048-495-C	R-12, R-22, R-502	1/4" SAE



**IDEAL®** is a leading manufacturer and supplier of clamping and joint sealing products world-wide.

## Micro-Gear Clamps

Micro-Gear clamps are tiny, tough and precision engineered for use in such small hose applications as emission control, fuel lines, etc. Their slim, 5/16" band and low profile housing make them easy to install in confined areas.



Part No.	SAE Sizes	Diameter (in.)		Std. Pkg.
		Min.	Max.	
091-6204	4	1/4"	5/8"	10
091-6206	6	5/16"	7/8"	10
091-62P08	8	3/8"	1"	10
091-62P20	20	3/4"	1-3/4"	10

## Hose Clamps

**50 Series** - Our most popular full-size clamp.



- Screw: 5/16" hex-head
- Plated carbon steel
- Band and housing: 9/16" - 201/301 grade stainless steel

**54 Series** - The professional mechanic's choice.



- Screw: 3/8" safety-collared hex head
- Plated carbon steel
- Combo-hex: can use screwdriver/nutdriver/socket

Continued Next Page



## Hose Clamps

**64 Series** - All stainless steel construction.



- Screw: 3/8" hex-head
- 410 stainless steel
- Band and housing: 9/16" - 201-301 grade stainless steel

50	Part No.		SAE Sizes	Diameter (in.)	
	54	64		Min.	Max.
091-5006	091-5406	091-6406	6	3/8"	7/8"
091-5008	091-5408	091-6408	8	7/16"	1"
091-5010	091-5410	091-6410	10	1/2"	1-1/16"
091-5012	091-5412	091-6412	12	1/2"	1-1/4"
091-5016	091-5416	091-6416	16	11/16"	1-1/2"
091-5020	091-5420	091-6420	20	3/4"	1-3/4"
091-5024	091-5424	901-6424	24	1"	2"
091-5028	091-5428	091-6428	28	1-1/4"	2-1/4"
091-5032	091-5432	091-6432	32	1-1/2"	2-1/2"
091-5036	091-5436	091-6436	36	1-3/4"	2-3/4"
091-5040	091-5440	091-6440	40	2"	3"
091-5044	091-5444	091-6444	44	2-1/4"	3-1/4"
091-5048	091-5448	091-6448	48	2-1/2"	3-1/2"
091-5052	091-5452	091-6452	52	2-3/4"	3-3/4"
091-5056	091-5456	091-6456	56	3"	4"
091-5060	—	091-6460	60	3-1/4"	4-1/4"
091-5064	—	091-6464	64	2-1/2"	4-1/2"
091-5072	—	091-6472	72	3"	5"
091-5080	—	091-6480	80	3-1/2"	5-1/2"
091-5088	—	091-6488	88	4"	6"
091-5096	—	091-6496	96	4-1/2"	6-1/2"
091-50104	—	091-64104	104	5"	7"

## General Purpose Clamps

**67-6 Series** - More resistant to corrosion in salt water environments than 300 grade stainless steel products.



- Screw: 5/16" hex-head 316 stainless steel
- Band: 1/2" band with 316 stainless steel
- Housing: 316 stainless steel
- Marine grade clamp

Part No.	SAE Sizes	Min. Dia. (in)	Max. Dia. (in)	Min. Dia. (mm)	Max. Dia. (mm)	Fits Hose ID Min. (in)	Fits Hose ID Max. (in)
091-6706-6	6	3/8"	7/8"	10	22	5/16"	3/8"
091-6708-6	8	7/16"	1"	11	25	5/16"	1/2"
091-6710-6	10	1/2"	1-1/16"	13	27	3/8"	5/8"
091-6712-6	12	1/2"	1-1/4"	13	32	3/8"	3/4"
091-6716-6	16	11/16"	1-1/2"	18	38	3/4"	7/8"



## Filament Tape



- Utility grade designed for light duty packaging and strapping
- Strong, flexible polypropylene film for moisture and abrasion resistance, reinforced with uni-directional fiberglass filaments

Part No.	Description	Std. Pkg.
149-RG300.39	1/2" x 60 yd Filament Tape	72
149-RG300.41	1" x 60 yd Filament Tape	36
149-RG300.43	2" x 60 yd Filament Tape	24
149-RG300.40	3/4" x 60 yd Filament Tape	48

## Hot Melt Adhesive



- Excellent processing performance
- Superior adhesion properties
- Quiet release and easy unwind

Part No.	Description	Std. Pkg.
149-F4020-05	2" x 109 yd Hot Melt	36
149-F4039-05	3" x 109 yd Hot Melt	24

## Masking Tape



- Aggressive adhesive
- Good conformability and quick stick

Part No.	Description	Std. Pkg.
149-87202	1" x 60 yd Masking Tape	36
149-87201	2" x 60 yd Masking Tape	24
149-87217	3/4" x 60 yd Masking Tape	48
149-87218	1-1/2" x 60 yd Masking Tape	24



## All-Weather Colored Electrical Marking Tape



- 7 mil colored tape w/excellent adhesion
- Roll dimensions: .75 in x 60 ft

Part No.	Description	Std. Pkg.
149-84113	Green Electrical Tape	10/50
149-84114	White Electrical Tape	10/50
149-84116	Yellow Electrical Tape	10/50
149-84117	Blue Electrical Tape	10/50
149-84118	Red Electrical Tape	10/50



- 7 mil colored tape with excellent adhesion
- UL listed

Part No.	Description	Case Qty.
149-5681	.75 in x 60 ft, Brown	10/50
149-5682	.75 in x 60 ft, Orange	10/50

## Friction Tape



- Contractor-grade tape for wrapping low-voltage splices

Part No.	Description	Case Qty.
149-5516	.75 in x 60 ft	10/50

## Rubber Tape



- 30-mil, semi-cured rubber for low voltage electrical insulation
- Self-vulcanizing and water resistant

Part No.	Description	Case Qty.
149-5517	.75 in x 22 ft	100



## Dalo® and Texpen® Paint Markings

- Stainless steel-ball valve action tip
- Writes through oil, grease and underwater
- Write sharp, defined, bright marks on any surface including metal, plastic, glass, concrete, rubber and more
- Ergonomically correct marker that enables you to mark at all angles, even upsidedown
- Marker retains its shape unlike tube-style markers
- Paint flow is controlled by the pressure bulb at the end of the barrel
- Drying time: 25 - 35 minute



### Dalo® Markers

Part No.	Description	Std. Pkg.
087-26033	Medium Tip, Black	12
087-26013	Medium Tip, Blue	12
087-26043	Medium Tip, Green	12
087-26103	Medium Tip, Orange	12
087-26023	Medium Tip, Red	12
087-26083	Medium Tip, White	12
087-26063	Medium Tip, Yellow	12



### Texpen® Markers

Part No. Fine Tip	Part No. Medium Tip	Color	Std. Pkg.
087-16030	087-16033	Black	6
087-16010	087-16013	Blue	6
087-16040	087-16043	Green	6
087-16100	087-16103	Orange	6
087-16020	087-16023	Red	6
087-16080	087-16083	White	6
087-16060	087-16063	Yellow	6

## TW DYKEM®

### Brite Mark® Valve Action Markers

- Formula is not xylene-based
- Make permanent bright marks on metal, rubber, plastic, glass, concrete, leather, stone, wood, vinyl and more
- Heavy duty aluminum body with large paint capacity
- Drying time: 25 - 35 seconds



### Brite-Mark® Markers

Part No.	Description	Std. Pkg.
087-84002	Medium Tip, Black	12
087-84001	Medium Tip, Blue	12
087-84007	Medium Tip, Green	12
087-84005	Medium Tip, Orange	12
087-84006	Medium Tip, Red	12
087-84003	Medium Tip, White	12
087-84004	Medium Tip, Yellow	12

### Surface Preparation

**Steel Blue® Layout Fluid**

**Steel Red® Layout Fluid**

**Dykem Remover & Cleaner**

087-82038

- Resists cracking and chipping
- Reduces eye strain
- Toluene free
- Dries in minutes
- Add practically no thickness to work piece



Part No.	Description	Std. Pkg.
087-80000	16 oz. Aerosol, Steel Blue®	12
087-80096	16 oz. Aerosol, Steel Red®	12
087-82038	16 oz. Aerosol, Remover & Cleaner	12

## TW Cling Surface

### Cling Surface Spray Belt Dressing

Excellent for use on most auto belts, washer/dryer belts, power mower/snow blower belts, compressor belts, furnace blower belts, etc. Belt dressing stops belts from slipping and squeaking while keeping belts pliable.

- Stops slipping and squeaking
- Equalizes pressure
- Reduces vibrations
- Improves bearing and belt life
- Waterproof



087-10095

Part No.	Description	Std. Pkg.
087-10095	Spray Belt Dressing, 16 oz. Aerosol	12

## TW INSECT SHIELD™

### Insect Repellent Towels

The 30% DEET insect repellent formula provides a safe, yet highly effective level of protection. The towel allows for a one-step, controlled application making it safer than aerosol and pump spray to use around the face with no worry of inhaling mist or vapors.



087-91401

- 30% DEET (lasts up to 6 hours)
- Non-greasy
- Waterproof formula
- Protects from insects that carry the west Nile virus

Part No.	Description	Std. Pkg.
087-91401	Insect Repellent Towels, 100 Per Case	1/Case

## TW SCRUBS®

### Hand Cleaner Wipes

#### Scrubs-In-A-Bucket®

The patented, citrus-based formula is combined with a tough, textured blue towel to loosen, dissolve and absorb dirt and grease leaving your hands truly clean. The effectiveness of pumice soap in a premoistened towel.

- Removes: dirt, tar, oils, grease, paints, adhesives, epoxies, caulks, inks/dyes, urethanes, lubricants, "icky-pic", cable jelly, asphalt
- Also use on: tools, work surfaces, plastics, equipment, vinyl, painted surfaces, metal



087-42272

Part No.	Description	Std. Pkg.
087-42272	Scrubs-In-A-Bucket, 72/Bucket	6

#### Antimicrobial Scrubs Hand Sanitizer Wipes

combine a highly effective skin sanitizing formula and an abrasive, non-scratching towel for a one-step sanitizing system. This product dissolves contaminated biofilm and kills, absorbs, and removes disease causing germs and bacteria in seconds.

- Kills 99.9% of germs
- Prevents cross-contamination
- NSF registered
- Rapidly kills: 10-20 seconds
- MRSA
- Candida albicans
- E. coli
- Salmonella
- Pseudomonas aeruginosa
- Staphylococcus aureus (staph)
- Streptococcus pyogenes



087-90985

Part No.	Description	Std. Pkg.
087-90901	Scrubs Hand Sanitizer Wipes, (100 Packets)	1/Case
087-90985	Scrubs Hand Sanitizer Wipes, (85/Bucket)	6



### Cold Weld Compound

J-B Weld is a remarkably easy, convenient and inexpensive alternative to welding, soldering and brazing. J-B Weld is waterproof; petroleum, chemical and acid resistant when fully cured. It can be drilled, tapped, machined, filed, sanded and painted.

- Tensile strength: 3960 PSI
- Adhesion strength: 1800 PSI
- Flexural strength: 7320 PSI
- Compressive strength: 10733 PSI



077-8265



077-8265S

Part No.	Description	Std. Pkg.
077-8265	JB Weld Display	6
077-8265S	JB Weld Card Pack	6

### Kwik Weld

J-B Kwik is the perfect partner for the J-B Weld you keep in your tool box. Lots of times, you need to fix something fast and don't have the time or patience to hold it for half an hour while the hardener sets up, or wait for it to cure overnight. That's why there's J-B Kwik!

- Tensile strength: 2100 PSI
- Adhesion strength: 1800 PSI
- Flex Strength: 7320 PSI
- Tensile Lap Shear: 1040 PSI
- Shrinkage: 0.0%
- Resistant to: 300°F



077-8276

Part No.	Description	Std. Pkg.
077-8276	JB Kwik Adhesive	6





## Industro Weld

JB Weld in a shop pack  
Contains (2) 5 oz. tubes



077-8280

Part No.	Description	Std. Pkg.
077-8280	5 Oz. Shop Pack	24

## Perm-O-Seal Weld

Perm-O-Seal is a non-toxic mixture of seven organic ingredients designed to permanently seal holes and cracks in radiators, water jackets and cylinder heads. Just pour Perm-O-Seal into the radiator while the engine is running. It speeds through the water channels, seeks out holes and swells shut as soon as it comes in contact with air (on the other side of the hole). It will be redissolve and draining or flushing will not affect the seal.

America's #1 permanent sealant for radiators, water jackets, and cylinder heads.



077-DS114

Part No.	Description	Std. Pkg.
077-DS114	Perm-O-Seal Sealant	24



## All-Purpose Hand Cleaner

Joe's creamy formula liquifies and gently lifts grease, grime and stains from the hands cleaned conditioned and without the greasy feeling. The lanolin and skin care emollients help heal rough, dry and overused hands.



012-101-P



012-105



012-104



012-103



012-109

Part No.	Description	Std. Pkg.
012-101-P	Hand Cleaner - 4.5 lb. Plastic Can	6
012-102	Hand Cleaner - 30 oz. Plastic Can	12
012-103	Hand Cleaner - 1 lb. Plastic Can	24
012-104	Hand Cleaner - 5 Gallon Pail	1
012-105	Hand Cleaner - 15 oz. Squeeze Tube	12
012-106	Hand Cleaner - 55 Gallon Drum	1
012-109	Hand Cleaner - 1 Gallon Plastic Pail	2



Joe's Hand Cleaner has served millions of Americans since 1948





## Joe's Hand Scrub

With Polyethylene Scrubbers

Joe's Hand Scrub is made with the same formula as the all-purpose hand cleaner featuring a gentle polyethylene scrubber. Constant partial size blends evenly and thoroughly.



012-401-P



012-405

Part No.	Description	Std. Pkg.
012-401-P	Hand Cleaner - 4.5 lb. Plastic Can	6
012-405	Hand Cleaner - 15 oz. Squeeze Tube	12
012-409	Hand Cleaner - 1 Gallon Plastic Pail	2

## Joe's Citrus Blue

Formulated with nature's natural d-limonene solvent for safe cleaning, balanced skin conditioning and fresh scent of citrus. A distinctive blue color to bring a new level of cleaning the smell of work off your hands.



012-501-P



012-505



012-500

Part No.	Description	Std. Pkg.
012-500	Citrus Blue - 3.5 lb. Plastic Container w/Pump Disp.	6
012-501-P	Citrus Blue - 4.5 lb. Plastic Can	6
012-505	Citrus Blue - 15 oz. Squeeze Tube	12
012-509	Citrus Blue - 1 Gallon Plastic Pail	2

## Dispensers/Misc.



012-310

Glass Cleaner



012-203

Part No.	Description	Std. Pkg.
012-1310	Stainless Steel Wall Mount, for 4.5 lb. Cans	1
012-203	Joe's Glass Cleaner, 19 oz. Aerosol	12
012-301-G	Plastic Pump, for 401-P - 4.5 lb. Can	1
012-301-P	Plastic Pump, for 101-P & 501-P - 4.5 lb. Can	1
012-309	Plastic Pump, for 109 & 509 - 1 Gallon Pails	1
012-310	Plastic Wall Dispenser for 101, 401 & 501 - 4.5 lb.	1
012-366	Dispenser for 55 Gallon Drum	1



## Anti-Seize & Thread Lubricant

Kopr-Kote is a combination of copper flake, graphite and other extreme pressure additives, blended into a food grade grease base that helps properly distribute all the components on the surface of the fastener or the metal surface needing lubrication. This particle distribution is necessary to achieve the .15 K-Factor and aids in the break out process by reducing metal to metal contact that can cause friction, heat and damage to the threaded surface.

- -65° to 1800°F (-54°C to 982°C)
- NSF Registered (H-2)
- MIL PRF-907E
- Load rating - 80,000 PSI
- Friction Coefficient (K-factor) - .15
- 10% pure metallic copper flake



Part No.	Description	Std. Pkg.
202-10004	Kopr-Kote 1/2 lb. Brush Top	12 Ea.
202-10007	Kopr-Kote 1 lb. Brush Top	12 Ea.



## Ratchets



Part No.	Description	Std. Pkg.
145-C4468-15P	1/2" Dr. Reversible Ratchet Polish, 15"	1 Ea.



Part No.	Description	Std. Pkg.
145-C4679-20F	3/4" Dr. Reversible Ratchet Knurl, 20"	1 Ea.



Part No.	Description	Std. Pkg.
145-C4879-32F	1" Dr. Reversible Ratchet Knurl, 32"	1 Ea.

## Impact Socket Sets

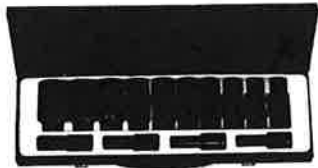

1/2" drive impact deep sockets, 6pt., 3/8", 7/16", 1/2", 9/16", 5/8", 11/16", 3/4", 13/16", 7/8", 15/16", 1", 1-1/16", 1-1/8", 1-1/4"

Part No.	Description	Std. Pkg.
145-A4406SP	14 Pc. Deep Impact Socket Set SAE 6 Pt.	1

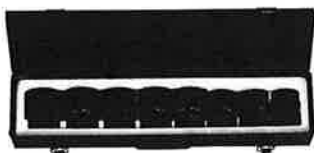

3/4" drive impact standard sockets, 6 pt. 1", 1-1/16", 1-1/8", 1-1/4", 1-5/16", 1-3/8", 1-7/16", 1-1/2"

Part No.	Description	Std. Pkg.
145-A6402SP10	8 Pc. Impact Socket Set SAE 6 Pt.	1

## Impact Socket Sets (Cont.)



3/4" drive impact deep sockets, 6 pt. 1", 1-1/16", 1-1/8", 1-1/4", 1-5/16", 1-3/8", 1-7/16", 1-1/2"

Part No.	Description	Std. Pkg.
145-A6403SP	8 Pc. Deep Impact Socket Set SAE 6 Pt.	1

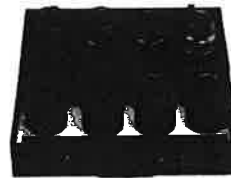

1" drive impact standard sockets, 6 pt. 15/16", 1-1/16", 1-3/16", 1-1/4", 1-5/16", 1-7/16", 1-1/2", 1-5/8"

Part No.	Description	Std. Pkg.
145-A8403SP	8 Pc. Impact Socket Set SAE 6 Pt.	1

## 1/2" Standard Impact Sockets

### 1/2" Dr. Impact Socket SAE 6 Pt.



Part No.	Size	Lbs.
145-D1410S10	5/16"	0.14
145-D1410S12	3/8"	0.15
145-D1410S14	7/16"	0.16
145-D1410S16	1/2"	0.16
145-D1410S18	9/16"	0.17
145-D1410S20	5/8"	0.24
145-D1410S22	11/16"	0.26
145-D1410S24	3/4"	0.26
145-D1410S26	13/16"	0.29
145-D1410S28	7/8"	0.31
145-D1410S30	15/16"	0.33
145-D1410S32	1"	0.37
145-D1410S34	1-1/16"	0.39
145-D1410S36	1-1/8"	0.44
145-D1410S38	1-3/16"	0.44
145-D1410S40	1-1/4"	0.45



## 1/2" Deep Impact Sockets

1/2" Dr. Deep Impact Socket SAE 6 Pt.



Part No.	Size	Lbs.
145-D1430S12	3/8"	0.33
145-D1430S14	7/16"	0.33
145-D1430S16	1/2"	0.35
145-D1430S18	9/16"	0.37
145-D1430S20	5/8"	0.51
145-D1430S22	11/16"	0.52
145-D1430S24	3/4"	0.53
145-D1430S26	13/16"	0.53
145-D1430S28	7/8"	0.64
145-D1430S30	15/16"	0.68
145-D1430S32	1"	0.74
145-D1430S34	1-1/16"	0.78
145-D1430S36	1-1/8"	0.88
145-D1430S38	1-3/16"	0.90
145-D1430S40	1-1/4"	0.93

## 1/2" Impact Accessories

1/2" Dr. Impact Extension Bar with Ball



Part No.	Size	Lbs.
145-D5420-03P	3"	0.43
145-D5420-06P	6"	0.75
145-D5420-10P	10"	0.99

1/2" Dr. Impact Adapter



Part No.	Size	Lbs.
145-D5486	3/4" M x 1/2" F	0.33

## 1/2" Impact Accessories (Cont.)

1/2" Dr. Impact Adapter with Ball



Part No.	Size	Lbs.
145-D5486P	3/4" M x 1/2" F	0.33

## 3/4" Standard Impact Sockets

3/4" Dr. Impact Socket SAE 6 Pt.



Part No.	Size	Lbs.
145-D1610S22	11/16"	0.50
145-D1610S24	3/4"	0.52
145-D1610S26	13/16"	0.56
145-D1610S28	7/8"	0.57
145-D1610S30	15/16"	0.57
145-D1610S32	1"	0.57
145-D1610S34	1-1/16"	0.73
145-D1610S36	1-1/8"	0.80
145-D1610S38	1-3/16"	0.82
145-D1610S40	1-1/4"	1.03
145-D1610S42	1-5/16"	1.05
145-D1610S44	1-3/8"	1.09
145-D1610S46	1-7/16"	1.12
145-D1610S48	1-1/2"	1.21
145-D1610S50	1-9/16"	1.29
145-D1610S52	1-5/8"	1.30
145-D1610S54	1-11/16"	1.40
145-D1610S56	1-3/4"	1.36
145-D1610S58	1-13/16"	1.57
145-D1610S60	1-7/8"	2.04
145-D1610S62	1-15/16"	2.10
145-D1610S64	2"	2.10
145-D1610S66	2-1/16"	2.38
145-D1610S68	2-1/8"	2.48
145-D1610S70	2-3/16"	2.54
145-D1610S72	2-1/4"	2.66
145-D1610S74	2-5/16"	2.75
145-D1610S76	2-3/8"	2.97



### 3/4" Deep Impact Sockets

3/4" Dr. Deep Impact Socket SAE 6 Pt.



Part No.	Size	Lbs.
145-D1630S24	3/4"	1.23
145-D1630S26	13/16"	1.30
145-D1630S28	7/8"	1.34
145-D1630S30	15/16"	1.38
145-D1630S32	1"	1.45
145-D1630S34	1-1/16"	1.45
145-D1630S36	1-1/8"	1.48
145-D1630S38	1-3/16"	1.52
145-D1630S40	1-1/4"	1.60
145-D1630S42	1-5/16"	1.73
145-D1630S44	1-3/8"	1.78
145-D1630S46	1-7/16"	1.79
145-D1630S48	1-1/2"	1.94
145-D1630S50	1-9/16"	2.05
145-D1630S52	1-5/8"	2.06
145-D1630S54	1-11/16"	2.46
145-D1630S56	1-3/4"	2.60
145-D1630S58	1-13/16"	2.77
145-D1630S60	1-7/8"	3.05
145-D1630S62	1-15/16"	3.18
145-D1630S64	2"	3.24

### 3/4" Impact Accessories

3/4" Dr. Impact Extension Bar, Black with Ball



Part No.	Size	Lbs.
145-D5620-07P	7"	1.89

3/4" Dr. Impact Universal Joint with Ball



Part No.	Size	Lbs.
145-D5671P	4-1/2"	1.63

3/4" Dr. Impact Adapter with Ball



Part No.	Size	Lbs.
145-D5684P	3/4" F x 1/2" M	0.68
145-D5688P	3/4" F x 1" M	0.91

### 1" Standard Impact Sockets

1" Dr. Impact Socket SAE 6 Pt.



Part No.	Size	Lbs.
145-D1810S24	3/4"	1.12
145-D1810S26	13/16"	1.16
145-D1810S28	7/8"	1.16
145-D1810S30	15/16"	1.16
145-D1810S32	1"	1.25
145-D1810S34	1-1/16"	1.25
145-D1810S36	1-1/8"	1.32
145-D1810S38	1-3/16"	1.30
145-D1810S40	1-1/4"	1.49
145-D1810S42	1-5/16"	1.54
145-D1810S44	1-3/8"	1.71
145-D1810S46	1-7/16"	1.60
145-D1810S48	1-1/2"	1.63
145-D1810S50	1-9/16"	1.76
145-D1810S52	1-5/8"	1.86
145-D1810S54	1-11/16"	1.96
145-D1810S56	1-3/4"	2.20
145-D1810S58	1-13/16"	2.37
145-D1810S60	1-7/8"	2.39
145-D1810S62	1-15/16"	2.51
145-D1810S64	2"	2.72
145-D1810S66	2-1/16"	2.86
145-D1810S68	2-1/8"	3.08
145-D1810S70	2-3/16"	3.15
145-D1810S72	2-1/4"	3.30
145-D1810S74	2-5/16"	3.39
145-D1810S76	2-3/8"	3.87
145-D1810S78	2-7/16"	3.87
145-D1810S80	2-1/2"	3.85
145-D1810S82	2-9/16"	3.87
145-D1810S84	2-5/8"	4.33
145-D1810S86	2-11/16"	4.33
145-D1810S88	2-3/4"	4.65
145-D1810S90	2-13/16"	6.44
145-D1810S92	2-7/8"	6.71
145-D1810S94	2-15/16"	7.01
145-D1810S96	3"	7.05
145-D1810SA0	3-1/8"	7.37
145-D1810SA4	3-1/4"	7.26
145-D1810SA8	3-3/8"	7.81
145-D1810SB2	3-1/2"	8.69



## 1" Deep Impact Sockets

1" Dr. Deep Impact Socket SAE 6 Pt.



Part No.	Size	Lbs.
145-D1830S30	15/16"	1.87
145-D1830S32	1"	1.91
145-D1830S34	1-1/16"	1.94
145-D1830S36	1-1/8"	2.06
145-D1830S38	1-3/16"	2.06
145-D1830S40	1-1/4"	2.16
145-D1830S42	1-5/16"	2.24
145-D1830S44	1-3/8"	2.27
145-D1830S46	1-7/16"	2.27
145-D1830S48	1-1/2"	2.27
145-D1830S50	1-9/16"	2.37
145-D1830S52	1-5/8"	2.39
145-D1830S54	1-11/16"	2.39
145-D1830S56	1-3/4"	2.87
145-D1830S58	1-13/16"	2.90
145-D1830S60	1-7/8"	3.09
145-D1830S62	1-15/16"	3.11
145-D1830S64	2"	3.20
145-D1830S66	2-1/16"	3.60
145-D1830S68	2-1/8"	3.85
145-D1830S70	2-3/16"	4.05
145-D1830S72	2-1/4"	4.24

## 1" Impact Accessories

1" Dr. Impact Extension Bar with Ball



Part No.	Size	Lbs.
145-D5820-07P	7"	3.06

## 1" Impact Accessories (Cont.)

1" Dr. Impact Universal Joint with Ball



Part No.	Size	Lbs.
145-D5871P	5"	3.37

1" Dr. Impact Adapter



Part No.	Size	Lbs.
145-D5886P	1" F x 3/4" M	1.30

## 1-1/2" Deep Impact Sockets

1-1/2" Dr. Deep Impact Socket SAE 6 Pt.



Part No.	Size	Lbs.
145-D1910S64	2"	5.08
145-D1910S66	2-1/16"	5.08
145-D1910S68	2-1/8"	5.27
145-D1910S70	2-3/16"	5.59
145-D1910S72	2-1/4"	5.81
145-D1910S74	2-5/16"	6.01
145-D1910S76	2-3/8"	6.09
145-D1910S78	2-7/16"	6.29
145-D1910S80	2-1/2"	6.53
145-D1910S82	2-9/16"	6.75
145-D1910S84	2-5/8"	7.00
145-D1910S86	2-11/16"	7.11
145-D1910S88	2-3/4"	7.50
145-D1910S90	2-13/16"	7.79
145-D1910S92	2-7/8"	7.85
145-D1910S94	2-15/16"	7.83
145-D1910S96	3"	8.16



## Tape Measures

### PowerGlide Pocket Tape



- Fantastic tapes at a reasonable price
- Chrome-plated tape armor adds strength
- Nylon-coated, no-glare, 1" blade
- Insty-Ready™ blades, labels 1/8ths, 1/16ths, continuous inches, 16" studs and 19.2 truss

Part No.	Size/Units	Std. Pkg.
098-PG1016	1" x 16', ft., 1/10, 1/100	20
098-PG1025	1" x 25', ft., 1/10, 1/100	20
098-PG10M25	1" x 25', ft., 1/10, 1/100 & metric	20
098-PG181025	1" x 25', ft., in., 1/8, 1/16, 1/10, 1/100	20
098-PG1816	1" x 16', ft., in., 1/8, 1/16	20
098-PG1825	1" x 25', ft., in., 1/8, 1/16	20
098-PG1830	1" x 30', ft., in., 1/8, 1/16	20

### Economy Engineer Tape



- Lacquer-coated steel blade
- Gold housing with rubber grip

Part No.	Size/Units	Std. Pkg.
098-PG25	1" x 25', ft., in., 1/8, 1/16	24
098-PG2510	1" x 25', ft., 1/10, 1/100	24

### Wood Ruler

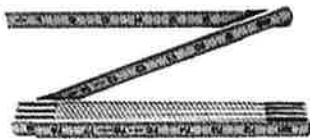

- Folds down to 9 1/2"
- Opens up to 6 1/2' ft. & in./ft. & 10ths

Part No.	Size/Units	Std. Pkg.
098-WR1018	6 1/2' Wood Ruler	10

## Plumb



- Comply with the Government Spec: GGG-P-Sole
- Sizes: 8 oz. and 16 oz.

Part No.	Size/Units	Std. Pkg.
098-BPB8	Brass Plumb Bob, 8 oz.	24
098-BPB16	Brass Plumb Bob, 16 oz.	12

## Tape Measures - Large

The Ultra-Glass® fiberglass reinforced tape was designed to withstand more wear and tear than any other type of fiberglass measuring tape. Has a proven dielectric strength of 200,000 V/M to assure your safety from electrical hazards.



- Tough, molded handle is easy to grasp
- The crank handle is reinforced with metal to provide years of rugged use
- Double-throat rollers guide the blade return and prevent the tape from twisting
- The shovel handle is ideal for rapid reeling

## Open-Type Housing

Part No.	Size/Units	Std. Pkg.
098-OTR1050	1/2" x 50', ft., 1/10, 1/100	10
098-OTR10100	1/2" x 100', ft., 1/10, 1/100	10
098-OTR18200	200', ft., in., 1/8 & ft., 1/10, 1/100	10

## Steel Housing, Nylon-Reinforced Steel Blade-SNR

- The strongest housing (stainless steel) on the market
- Tough, double nylon-coated steel blade assures long life
- Housing reinforced with rivets for superior strength
- Blade: 3/8" Perma-Clad™ steel



Part No.	Size/Units	Std. Pkg.
098-SNR18100	3/8' x 100', ft., in., 1/8	5/10
098-SNR18200	3/8' x 200', ft., in., 1/8	5/10
098-SNR18300	3/8' x 300', ft., in., 1/8	2/5



## Fiberglass Measuring Tape

### Closed-Type Housing



- Fiberglass tape - metal case
- Housing - closed metal, black
- Blade: 1/2" Ultra-Glass®

Part No.	Size/Units	Std. Pkg.
098-MC1050	1/2" x 50', ft., in., 1/8	5/20 mast.

## Mason Twine



- Fluorescent Orange
- Braided Nylon
- 18-gauge
- Tensile strength - 155 lbs.
- Length - 250 ft.

Part No.	Description	Std. Pkg.
098-OB250	Braided Nylon Mason Twine - Orange	12/48

## Measuring Tools



- Diameter 15-1/2 in.
- Huge numbers make for easy reading (5 digits, up to 99,999)
- 3/4 in. steel frame
- Compact - folds in half for storage

Part No.	Description	Std. Pkg.
098-MP401	Metal Professional Measuring Wheel	1



- Basic metal chalk reel
- Compact and super light
- Doubles as a plumb bob
- Self-sealing grommet for spill-free refills

Part No.	Description	Std. Pkg.
098-K1	All Metal Design, 2 oz. Capacity 100 ft., Thin String	12

## Marking Chalk



- Ultra-fine marking chalk
- Formulated to achieve a perfect line every time.
- Brilliant color oxides added to assure constant color tones for strong sharp lines.
- 8 ounce bottle

Part No.	Description	Std. Pkg.
098-8B	8 oz. Blue Marking Chalk	48
098-8R	8 oz. Red Marking Chalk	48



**Pro Line™** extinguishers, from Kidde, feature metal valves and aluminum or steel cylinders and are designed to meet most commercial and industrial applications. ABC type dry chemical extinguishers use a non-toxic monoammonium phosphate agent that effectively fights A, B and C class fires.

**Excel Line™** extinguishers have corrosion-resistant nylon valves and aluminum cylinders that can stand up to rugged environments and extreme conditions.

**ABC Disposable** extinguishers from Kidde are lightweight, easy-to-use and are the perfect answer for areas that need supplemental protection. These seamless aluminum cylinders have no welds so they won't leak.



Part No.	Description/Rating	Std. Pkg.
129-466142K	2.5 lb. ABC Disposable Extinguisher	1
129-4662-112	5 lb. ABC Pro Line Extinguisher w/Wall Hook 3A:40B:C Rating	4
129-466204	10 lb. ABC Pro Line Extinguisher w/Wall Hook 4A:60B:C Rating	1
129-466206	20 lb. ABC Pro Line Extinguisher w/Wall Hook 10A:80B:C Rating	1
129-466225	2.5 lb. ABC Excel Line Extinguisher w/Nylon Vehicle Bracket - 1A:10B:C Rating	6
129-466425	5 lb. ABC Rechargeable Fire Extinguisher	1



## Kidde

### Mounting Brackets

These brackets is characterized by a metal piece that extends outward from the bottom of the bracket away from the wall and fitting underneath the bottom of the extinguisher.

Heavy duty running board bracket for 20 lb. extinguishers.



129-292474

Heavy duty running board bracket for 10 lb. extinguishers.



129-366242

Metal mounting bracket with strap. Secure your extinguisher so that it is ready and available when you need it.



129-466400

Part No.	Description	Std. Pkg.
129-292474	Running Board Bracket for the 466204	1
129-366242	Running Board Bracket for the 466225	1
129-466400	Metal Bracket with Strap for the 466112 and the 466425	1



## KOLOR KUT®

### Water Finding Paste

Kolor Kut water finding paste is golden brown in color and turns brilliant red upon contact with water. This product will successfully gauge water content in all petroleum and hydrocarbons as well as sulfuric acid, nitric acid, hydrochloric acid, ammonia, soap solutions, salt and other chloride solutions.



004-KK01

Part No.	Description	Std. Pkg.
004-KK01	Kolor Kut Water Finding Paste, 3 oz. Tube	12

### Gas Gauging Paste

Kolor Kut gas gauging paste is light pink in color and turns red upon contact with gasoline, diesel, naphtha, kerosene, gas oil, crude oil, jet fuels and other hydrocarbons. A most effective product level indicator.



004-KK02

Part No.	Description	Std. Pkg.
004-KK02	Kolor Kut Gas Gauging Paste, 2.25 oz. Jar	12



## KRYLON

### 5-Ball Interior-Exterior Paint

Krylon® Industrial (5-Ball) Interior-Exterior paint is the #1 brand in spray paints. These paints are specifically formulated for industrial maintenance and touch-up applications. Performance is exceptional and they dry in 12 minutes or less.

- The most asked for spray paint in the industrial marketplace
- Superior performance, both indoors and outdoors
- Hard, protective, durable finish
- High amount of solids assures maximum coverage with excellent adhesion
- Tough, high-glass finish
- Uniform coverage



Part No.	Description	Case Qty.
065-K01501	5 Ball, Gloss White, 16 Oz. Spray Paint	6
065-K01502	5 Ball, Flat White, 16 Oz. Spray Paint	6
065-K01508	5 Ball, Semi-Gloss White, 16 Oz. Spray Paint	6
065-K01601	5 Ball, Gloss Black, 16 Oz. Spray Paint	6
065-K01602	5 Ball, Ultra-Flat Black, 16 Oz. Spray Paint	6
065-K01604	5 Ball, Shadow Gray, 16 Oz. Spray Paint	6
065-K01605	5 Ball, Stone Gray, 16 Oz. Spray Paint	6
065-K01608	5 Ball, Smoke Gray, 16 Oz. Spray Paint	6
065-K01613	5 Ball, Semi-Flat Black, 16 Oz. Spray Paint	6
065-K01806	5 Ball, Sun Yellow, 16 Oz. Spray Paint	6
065-K01901	5 Ball, Regal Blue, 16 Oz. Spray Paint	6
065-K01910	5 Ball, True Blue (Osha Safety Blue), 16 Oz. Spray Paint	6
065-K02001	5 Ball, Hunter Green, 16 Oz. Spray Paint	6
065-K02016	5 Ball, Emerald Green, 16 Oz. Spray Paint	6
065-K02101	5 Ball, Cherry Red, 16 Oz. Spray Paint	6
065-K02501	5 Ball, Leather Brown, 16 Oz. Spray Paint	6
065-K02504	5 Ball, Khaki, 16 Oz. Spray Paint	6
065-K01315	5 Ball, White Primer, 16 Oz. Spray Paint	6
065-K01316	5 Ball, Charcoal Black Primer, 16 Oz. Spray Paint	6
065-K01317	5 Ball, Ruddy Brown Primer, 16 Oz. Spray Paint	6
065-K01318	5 Ball, Gray Primer, 16 Oz. Spray Paint	6





### Rust Tough® Acrylic Enamel

Rust Tough® Aerosols are rust-preventative acrylic alkyd enamel that offers state-of-the-art corrosion protection. Rust Tough™ provides excellent gloss and color retention, superior durability and one-coat coverage.

- Complete coverage with one coat
- Dries to touch in 25 minutes; dries to handle in 1 hour
- Superior appearance and color retention
- Ideal for small touch-up jobs, painting irregular shapes or covering hard-to-reach areas
- For both indoor and outdoor use
- Tough, high gloss finish resists chipping and peeling



Part No.	Description	Case Qty.
065-R00339	Rust Tough, Safety Green (OSHA), 20 Oz. Aerosol	6
065-R00479	Rust Tough, Industrial Yellow, 20 Oz. Aerosol	6
065-R00649	Rust Tough, Bright Red, 20 Oz. Aerosol	6
065-R00929	Rust Tough, Gloss White, 20 Oz. Aerosol	6
065-R10559	Rust Tough, Fluorescent Orange, 20 Oz. Aerosol	6

### Tough Coat® Acrylic Enamel

Tough Coat® Acrylic alkyd enamels feature a high-solids formula that ensures maximum coverage and performance. Tough Coat® delivers the ultimate in protection, durability, high gloss and color retention.

- Specially formulated for a variety of industrial applications
- Ideal for light-to heavy-duty painting projects, both indoors and outdoors
- Tough, protective coating resists chipping and peeling
- Excellent hiding characteristics
- Smooth, even coverage
- Fast-drying; dries to the touch in just 15 minutes
- Acrylic enamel formulation



Part No.	Description	Case Qty.
065-S00325	Tough Coat, Machinery Dark Gray (ASA-49) 16 Oz., Acrylic Enamel	12
065-S01110	Tough Coat, OSHA Red, 16 Oz., Acrylic Enamel	12
065-S01310	Tough Coat, OSHA Yellow, 16 Oz., Acrylic Enamel	12
065-S01510	Tough Coat, OSHA Blue, 16 Oz., Acrylic Enamel	12
065-S01540	Tough Coat, Light Blue, 16 Oz., Acrylic Enamel	12
065-S01770	Tough Coat, OSHA Black, 16 Oz., Acrylic Enamel	12
065-S01800	Tough Coat, OSHA White, 16 Oz., Acrylic Enamel	12

### Quik-Mark™ Inverted Marking Paint

Quik-Mark™ solvent-based inverted marking paints have a high solids formulation that gives them the boldest, brightest and most visible markings in the industry. These fast-drying products penetrate and adhere to hot surfaces and deliver a line you can count on for all your surveying and marking needs.

- VOC compliant
- Free of lead hazards
- Convenient Spray Thru™ cap



Solvent-Based

Water-Based

#### Solvent-Based

Part No.	Description	Case Qty.
065-S03611	Quik-Mark™, APWA Red, 20 Oz., Marking Paint	12
065-S03621	Quik-Mark™, APWA Blue, 20 Oz., Marking Paint	12
065-S03631	Quik-Mark™, APWA Green, 20 Oz., Marking Paint	12
065-S03731	Quik-Mark™, APWA Burnt Orange, 20 Oz., Marking Paint	12
065-S03821	Quik-Mark™, APWA High Visibility Yellow 20 Oz., Marking Paint	12
065-S03823	Quik-Mark™, APWA Safety Yellow, 20 Oz., Marking Paint	12
065-S03900	Quik-Mark™, APWA Utility White, 20 Oz., Marking Paint	12
065-S03613	Quik-Mark™, Fluorescent Safety Red, 20 Oz., Marking Paint	12
065-S03614	Quik-Mark™, Fluorescent Neon Green, 20 Oz., Marking Paint	12
065-S03702	Quik-Mark™, Fluorescent Orange, 20 Oz., Marking Paint	12

#### Water-Based

Part No.	Description	Case Qty.
065-S03801	Quik-Mark™, APWA Utility Yellow, 20 Oz., Marking Paint	12
065-S03700	Quik-Mark™, Fluorescent Orange, 20 Oz., Marking Paint	12



## OSHA Paint

OSHA paints are a full-line of quality aerosol paints that meet color standards approved by the Occupational Safety and Health Act Governing Board.



- Mark physical hazards and designate caution for workers' safety
- High visibility safety colors

Part No.	Description	Case Qty.
065-K02116	OSHA, Safety Red, 12 Oz., Paint	6
065-K02410	OSHA, Safety Orange, 12 Oz., Paint	6
065-K01813	OSHA, Safety Yellow, 12 Oz., Paint	6
065-K02012	OSHA, Safety Green, 12 Oz., Paint	6
065-K02416	OSHA, Safety Blue, 12 Oz., Paint	6
065-K01929	OSHA, Safety Purple, 12 Oz., Paint	6

## Farm & Implement Paint

Farm & Implement paints are high-glass and durable coatings that meet manufacturer specifications for farm, vehicle, maintenance, lawn and garden equipment.



- Fast drying
- Original equipment colors
- High-glass, factory-like colors
- Weather and chemical resistant

Part No.	Description	Case Qty.
065-K01818	Farm & Implement, Am. Beauty/Int'l. Harvest Red, 12 Oz., Paint	6
065-K01816	Farm & Implement, John Deer Yellow, 12 Oz., Paint	6
065-K01817	Farm & Implement, John Deer Green 12 Oz., Paint	6

## Engine Paint

Engine Paints are fast-drying, high performance acrylic enamels that withstand temperatures up to 500°F. They are exact matches to OEM standards and are oil and gas resistant.



- Won't blister, flake, crack or peel

Part No.	Description	Case Qty.
065-K01923	Engine, Ford Dark Blue, 16 Oz., Paint	6
065-K01928	Engine, Chrysler Blue, 16 Oz., Paint	6
065-K02405	Engine, Chevrolet Orange, 16 Oz., Paint	6

## Fluorescent Indoor/Outdoor Paint

Fluorescent Indoor/Outdoor paints are available in a full range of bright colors that provide maximum visibility and safety. These paints glow under ultraviolet (black) light and increase brilliance by 200% to 400%.



- Apply over white base coat for optimum brightness
- Dries in 15 minutes or less
- Brilliant optical effect
- Bold neon colors for high visibility

Part No.	Description	Case Qty.
065-K03101	Fluorescent, Red Orange, 16 Oz., Paint	6
065-K03105	Fluorescent, Cerise, 16 Oz., Paint	6
065-K03106	Fluorescent, Green, 16 Oz., Paint	6

## High Heat & Radiator Paints

High Heat paints are special purpose paints that withstand temperatures up to 1,000°F. They provide a clean, durable finish and dry to touch in minutes.



- Protects against rust

Part No.	Description	Case Qty.
065-K01614	High Heat, Black, 12 Oz., Paint	6

## Metallic Paints

Metallic paints are fast-drying and easy-to-use. They leave a brilliant, metallic-like finish.



- Dries quickly
- Easy to use
- Brilliant metallic-like finish

Part No.	Description	Case Qty.
065-K01701	Metallic, Bright Gold, 12 Oz., Paint	6
065-K01401	Metallic, Bright Silver, 12 Oz., Paint	6
065-K01404	Metallic, Chrome Aluminum, 12 Oz., Paint	6