



STAIR & RAILING PRODUCTS BY

 **HOUSE OF
FORGINGS**

Powder Coated & Stainless Steel

**House of Forgings
is the benchmark in
the stair and railing
industry, offering an
unsurpassed
selection of quality
products and
expert service.**

Our vast selection of products will meet the needs of even the most discerning customers. Whether selecting a powder coated finish or stainless steel, our newels, balusters and accessories will compliment a broad range of architectural styles.

STAIR & RAILING PRODUCTS BY



Table of Contents

POWDER COATED & STAINLESS STEEL	2-57
Stainless Steel Cable Railing	2-5
Finishes & Patinas	6-7
Horizontal Bar Railing	8-11
Wentworth	12-15
Aalto	16-19
Tuscan	20-25
Orleans	26-27
Monte Carlo	28-29
Endecor	30-31
Designer	32-33
Stainless	34-35
Santa Fe	36-37
Gothic	38-39
Round	40-43
Versatile	44-47
Ribbon	48-51
Twist	52-55
Accessories	56-57
FORGED PANELS	58-79
Rebecca	59-61
Tuscany	62-65
Seville	66-67
Milano	68-70
Bordeaux	72-75
Regency	76-79
WOOD	80-91
Newels & Balusters	82-83
Elegante & Box Newels	84-85
Handrail & Fittings	86-87
Treads	88
Starter Steps	89
Lumber & Plywood	89
Moulding	90
Accessories	91
COMPANY & PRODUCT INFORMATION	92



Red Oak 4000 Newels, 6084 Handrail with stainless round bar bracket (shown)

Create the ideal modern aesthetic by combining stainless steel cable and rich oak. The expansive views allowed for by cable make it ideal for balconies as well as staircases.

— Stainless Steel —
Cable Railing

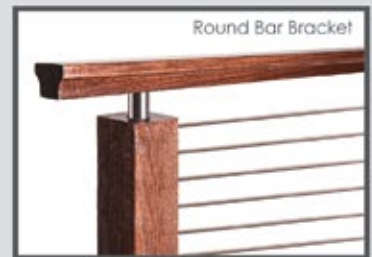
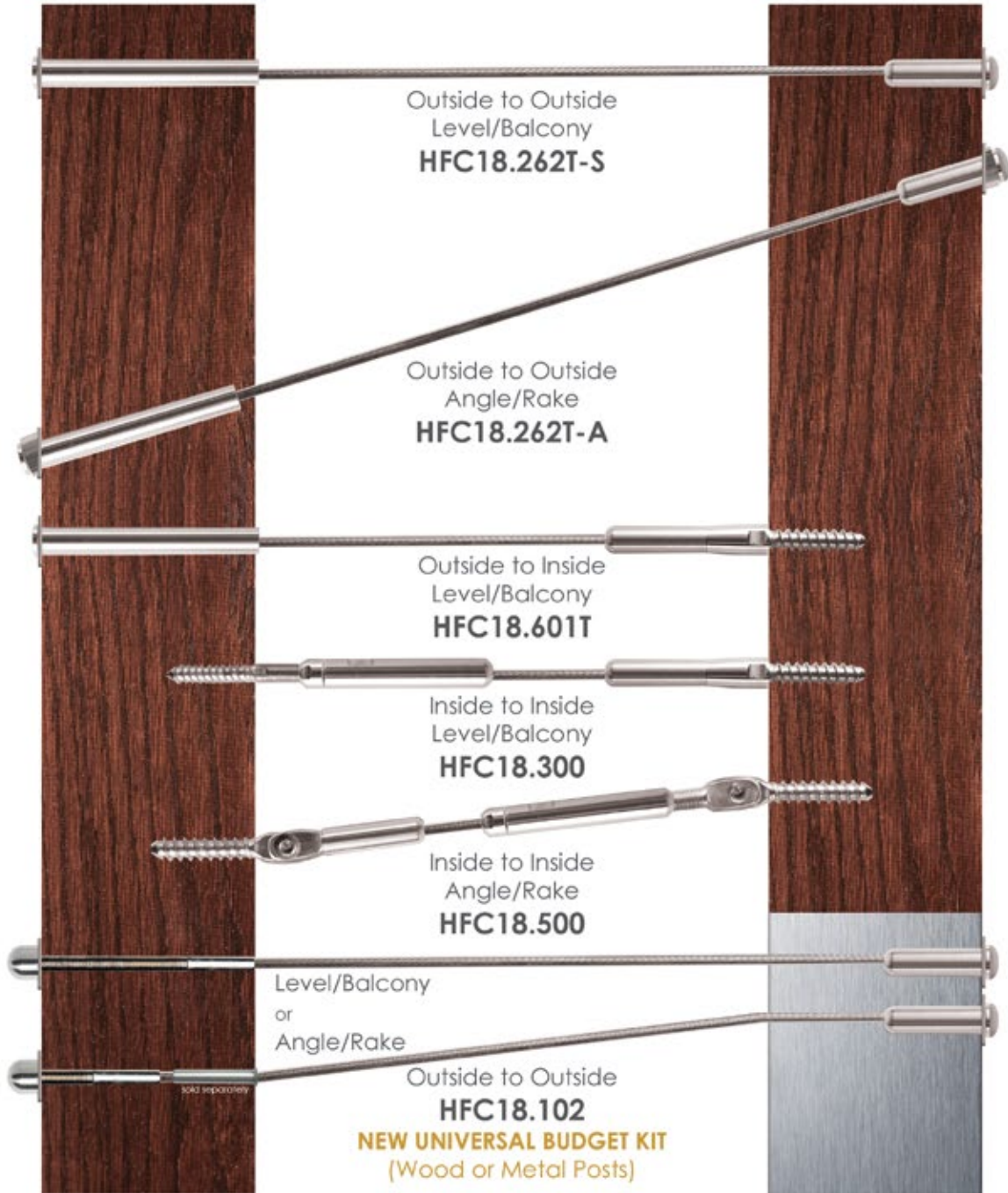

Outside to Outside Level/Balcony



- Invisiware Receiver: 3-5/8" length
- Pull Lock: 1-5/8" length

- HFC18.262T-S-5 (5ft)
- HFC18.262T-S-10 (10ft)
- HFC18.262T-S-15 (15ft)
- HFC18.262T-S-20 (20ft)
- HFC18.262T-S-25 (25ft)

Outside to Outside Angle/Rake



- HFC18.262T-A-5 (5ft)
- HFC18.262T-A-10 (10ft)
- HFC18.262T-A-15 (15ft)
- HFC18.262T-A-20 (20ft)
- HFC18.262T-A-25 (25ft)

Outside to Inside Level/Balcony



- HFC18.601T-A-5 (5ft)
- HFC18.601T-A-10 (10ft)
- HFC18.601T-A-15 (15ft)
- HFC18.601T-A-20 (20ft)
- HFC18.601T-A-25 (25ft)

NEW UNIVERSAL BUDGET KIT (Wood or Metal Posts)

Inside to Inside Level/Balcony



- HFC18.300-5 (5ft)
- HFC18.300-10 (10ft)
- HFC18.300-15 (15ft)
- HFC18.300-20 (20ft)
- HFC18.300-25 (25ft)

Inside to Inside Angle/Rake



- HFC18.500-5 (5ft)
- HFC18.500-10 (10ft)
- HFC18.500-15 (15ft)
- HFC18.500-20 (20ft)
- HFC18.500-25 (25ft)

Outside to Outside Level/Balcony or Angle/Rake



- HFC18.102-5 (5ft)
- HFC18.102-10 (10ft)
- HFC18.102-15 (15ft)
- HFC18.102-20 (20ft)
- HFC18.102-25 (25ft)

Cable can be bent up to 40 degrees for angle/rake applications.

All components are made from 316 Stainless Steel for marine grade corrosion resistance.

Additional lengths and bulk cable available by special order.

Modern Handrail

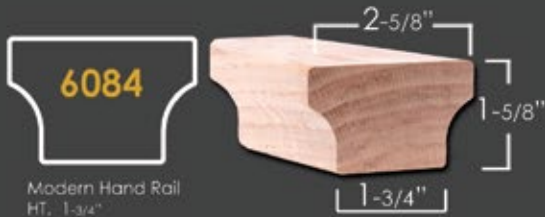

6084

Modern Hand Rail
HT. 1-3/4"
W. 2-5/8"

6084 Straight Rail
no fittings available



6002

Modern Hand Rail
HT. 1-5/8"
W. 2-3/4"

6002 Straight Rail
no fittings available

Wall Mount Handrail Bracket



HF17.4002
HT. 2-1/2"
Base = 1-1/2" x 2"
Extends 3-1/4" off wall
ADJUSTABLE



mounting hardware included

Newel



4000
HT. 54"
W = 3-1/4"

Intermediate Newel



4923-41
HT. 41"
W = 1-3/4"



Stainless Newel (cut to length for brackets)



HF17.1.2-T
Ends: 1-3/16" Rd.
HT. 47"
Wt. 5.7 lbs.
TUBULAR



Newel Mount Handrail Bracket



HF17.4001
HT. 1-3/4"
Base = 1-1/2" sq.
ADJUSTABLE



mounting hardware included

Insert Tube



Length: 1-1/2"
HFC18.TUBE

Release Key



HFC18.KEY

Newel Cap



SQUARE CAP-4000

3-1/4" Square
3/4" x 1" dowel
* All wood parts stocked in Red Oak



Cable Gripping Pliers



HFC18.PLIER

Cable Cutter



HFC18.CUTTER

Cable Cut-off Wheel



HFC18.WHEEL

Hanger Bolt Driver



HFC18.DRIVER



For use with
HFC18.500 kit

Stainless Cleaner-Protectant



HFC18.CLEAN

Finishes & Patinas



RAW IRON (RAW)

This is raw (unfinished) iron that needs to be painted or powder coated.



SATIN BLACK (STB)



ASH GREY (AG)



SILVER VEIN (SP)



COPPER VEIN (CV)



OIL RUBBED BRONZE (ORB)



OIL RUBBED COPPER (ORC)



ANTIQUE NICKEL (AN)



VINTAGE BRASS (VB)



SATIN CLEAR (SC)

This is a clear finish over RAW/unfinished iron, variations in surface color may occur.



DORADO GOLD (GD)



STAINLESS STEEL

THESE FINISHES HAVE BEEN PROFESSIONALLY PHOTOGRAPHED WITH THE HIGHEST INTEGRITY. OUR GOAL IS TO PRODUCE THE MOST REALISTIC MATCH TO THE ACTUAL FINISHES, HOWEVER SOME SLIGHT VARIANCES MAY OCCUR.
All images are the sole property of House of Forgings, LLC. and cannot be copied or reproduced without written permission.



SATIN BLACK

HFSTB5.1.1

Powder Coated Tubular Round Bar 5/8" Dia. x 8'

OIL RUBBED BRONZE **HFORB5.1.1**

Powder Coated Tubular Round Bar 5/8" Dia. x 8'

ASH GREY

HFAG5.1.1

Powder Coated Tubular Round Bar 5/8" Dia. x 8'

STAINLESS STEEL

HFSS5.1.1

304 Grade Stainless Steel Round Bar 5/8" Dia. x 8'

NEW
HORIZONTAL
RAILING

Now available exclusively from House of Forgings, powder coated and stainless steel tubular round bars. These sleek 5/8" bars are available in a convenient 8' length, ideal for installation and affordable shipping. Mix and match them with our exclusive components for a look that is completely custom and uniquely you.



Satin Black (shown)



Satin Black (shown)



Ash Grey (shown)



Satin Black (shown)

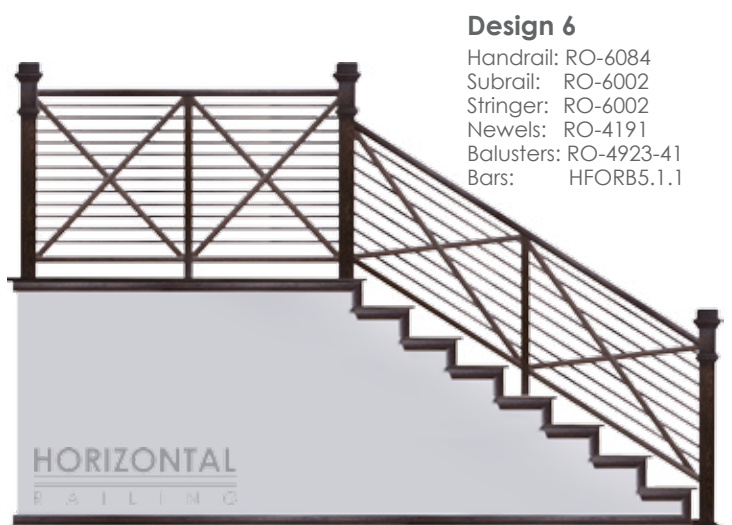
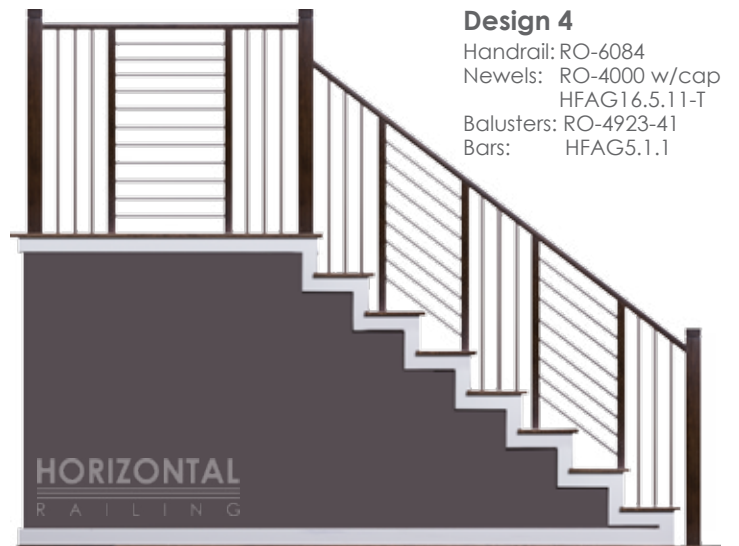
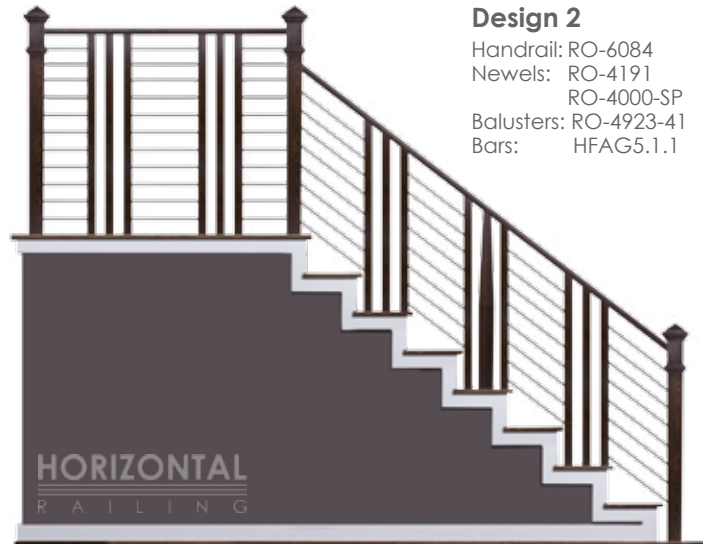
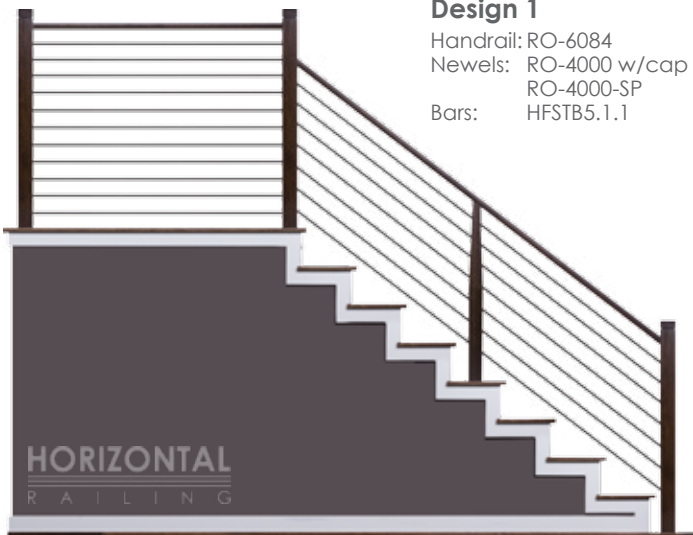

HORIZONTAL RAILING

ACCESSORIES

ROUND STAINLESS NEWEL

HF17.1.2-T
Ends: 1-3/16" Rd.
Height: 47"
Wt. 5.7 lbs.
TUBULAR

SQUARE NEWEL

HF 16.5.8
Ends: 1-3/16" Sq.
Height: 48"
Wt. 19 lbs.
SOLID

HF 16.5.8-T
Ends: 1-3/16" Sq.
Height: 48"
Wt. 4.8 lbs.
TUBULAR

ROUND NEWEL

HF 16.5.11
Ends: 1-3/16" Rd.
Height: 48"
Wt. 19 lbs.
SOLID

HF 16.5.11-T
Ends: 1-3/16" Rd.
Height: 48"
Wt. 5.7 lbs.
TUBULAR

BALUSTER

HF 16.8.1
Ends: 5/8" Rd.
Height: 44"
Wt. 2 lbs.
TUBULAR



Wall Mount Handrail Bracket



HF17.4002
HT. 2-1/2"
Base = 1-1/2" x 2"
Extends 3-1/4" off wall
ADJUSTABLE

Newel Mount Handrail Bracket



mounting hardware included



HF17.4001
HT. 1-3/4"
Base = 1-1/2" sq.
ADJUSTABLE



SQUARE CAP-4000
3-1/4" Square
3/4" x 1" dowel

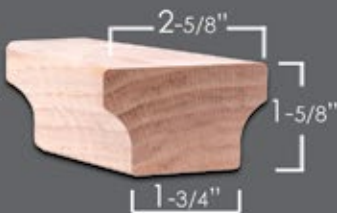

6084 Straight Rail
no fittings available



6002 Straight Rail
no fittings available



Oil Rubbed Bronze (shown)

WENTWORTH | COLLECTION

Inspired by old world English design, Wentworth Collection is an ode to an era of simple craftsmanship and metalsmithing. Hand forged design available in our most popular finishes & patinas.



Satin Black (shown)



Satin Clear (shown)



Satin Black (shown)



Oil Rubbed Bronze (shown)

NEW

WENTWORTH

ROUND HAND FORGED SQUARE RUSTIC HAMMERED



Finishes & Patinas

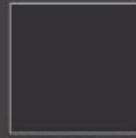

SATIN BLACK
(STB)



OIL RUBBED
BRONZE
(ORB)

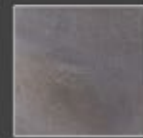

SATIN CLEAR
(SC)

ACCESSORIES

Round level base shoes
Round angled base shoes

HF16.3.35
HF16.3.36

Square level base shoes
Square angled base shoes

HF16.3.38
HF16.3.39

Round newel mounting kit
Square newel mounting kit

HF16.3.33
HF16.3.31







Photos: J.
Photos: N.

Photos: C.
Photos: G.

Photos: U.
Photos: T.

For photos and full accessory details see pages 56-57



 <p style="text-align: center;">NEWEL</p> <p style="text-align: center;">47"</p> <p>HF 1.1.22 Ends : 1" Rd. Height: 47" Wt. 18 lbs. SOLID</p>	 <p style="text-align: center;">44"</p> <p>HF 3.1.1 Ends : 5/8" Rd. Height: 44" Wt. 3.6 lbs. SOLID</p>	 <p style="text-align: center;">9-1/2"</p> <p style="text-align: center;">2"</p> <p style="text-align: center;">7"</p> <p style="text-align: center;">2"</p> <p style="text-align: center;">7"</p> <p style="text-align: center;">2"</p> <p style="text-align: center;">14-1/2"</p> <p>HF 3.1.2 Ends : 5/8" Rd. Height: 44" Wt. 3.58 lbs. SOLID</p>	 <p style="text-align: center;">NEWEL</p> <p style="text-align: center;">47"</p> <p>HF 1.1.23 Ends : 1" Sq. Height: 47" Wt. 18 lbs. SOLID</p>	 <p style="text-align: center;">44"</p> <p>HF 3.2.1 Ends : 5/8" Sq. Height: 44" Wt. 4.28 lbs. SOLID</p>	 <p style="text-align: center;">9-1/2"</p> <p style="text-align: center;">1-1/2"</p> <p style="text-align: center;">7-3/4"</p> <p style="text-align: center;">1-1/2"</p> <p style="text-align: center;">7-3/4"</p> <p style="text-align: center;">1-1/2"</p> <p style="text-align: center;">14-1/2"</p> <p>HF 3.2.2 Ends : 5/8" Sq. Height: 44" Wt. 5.2 lbs. SOLID</p>
---	--	---	---	---	--

Hand forged product, variance in specifications may occur.



Satin Black (shown)



Oil Rubbed Bronze (shown)

AALTO



Ash Grey (shown)

Ash Grey (shown)

Our Aalto collection is a compliment to the modern design aesthetic. Adorn any space with the clean lines and open detail of these modern balusters and panels.



Satin Black (shown)



Satin Black (shown)



Satin Black (shown)



Ash Grey (shown)



Ash Grey (shown)

AALTO

SQUARE



Finishes & Patinas

NEW



SATIN BLACK (STB)

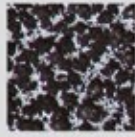

SILVER VEIN (SP)



COPPER VEIN (CV)



ASH GREY (AG)



DORADO GOLD (GD)

	NEWELS	HF16.5.8	HF16.5.8-T	BALUSTERS	HF16.2.1	HF16.2.1-T	HF16.2.1-50	HF16.1.30	HF16.1.30-T	HF16.1.31	HF16.1.31-T	HF16.1.32	HF16.1.32-T	HF16.6.1	HF16.6.2	HF16.6.3	HF16.6.4	HF16.6.5	HF16.6.7	HF16.6.8	HF16.6.9	HF9.4.1	HF9.4.2	HF9.4.3	HF9.4.4	HF9.4.11	HF9.4.22	HF9.4.33	HF9.4.44
STB		•			•	•	•	•		•		•		•	•	•	•	•	•	•	•	•	•	•	•	•	•	•	•
SP		•			•	•		•		•		•																	
CV		•			•	•		•		•		•																	
AG			•			•			•		•		•	•	•	•	•	•	•	•	•	•	•	•	•	•	•	•	•
GD		•			•									•		•				•	•	•							

ACCESSORIES

Level base shoes
 Level base collars
 Angled base shoes
 Newel mounting kit

HF16.3.1, HF16.3.19
HF16.3.4, HF16.3.5,
HF16.3.2, HF16.3.30
HF16.2.3

Photos: A. A.
 Photos: D. H.
 Photos: E. G.
 Photos: T.

For photos and full accessory details see pages 56-57



Satin Black (shown)



NEWEL

HF 16.5.8
Ends: 1-3/16" Sq.
Height: 48"
Wt. 19 lbs.
SOLID

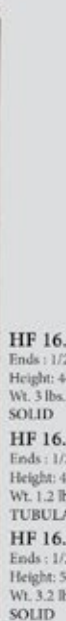

HF 16.2.1
Ends: 1/2" Sq.
Height: 44"
Wt. 3 lbs.
SOLID

HF 16.2.1-T
Ends: 1/2" Sq.
Height: 44"
Wt. 1.2 lbs.
TUBULAR



HF 16.1.30
Ends: 1/2" Sq.
Height: 44"
Wt. 3.4 lbs.
SOLID

HF 16.1.30-T
Ends: 1/2" Sq.
Height: 44"
Wt. 1.6 lbs.
TUBULAR



HF 16.1.31
Ends: 1/2" Sq.
Height: 44"
Wt. 3.6 lbs.
SOLID

HF 16.1.31-T
Ends: 1/2" Sq.
Height: 44"
Wt. 1.75 lbs.
TUBULAR



HF 16.1.32
Ends: 1/2" Sq.
Height: 44"
Wt. 10 lbs.
SOLID

HF 16.1.32-T
Ends: 1/2" Sq.
Height: 44"
Wt. 5 lbs.
TUBULAR



HF 16.6.1
Ends: 1/2" Sq.
Height: 44"
Wt. 1.2 lbs.
TUBULAR

NEW



HF 16.6.8
Ends: 1/2" Sq.
Height: 44"
Wt. 1.75 lbs.
TUBULAR

NEW



HF 16.6.9
Ends: 1/2" Sq.
Height: 44"
Wt. 1.6 lbs.
TUBULAR

NEW



HF 16.6.7
Ends: 1/2" Sq.
Height: 44"
Wt. 1.6 lbs.
TUBULAR



HF 16.6.2
Ends: 1/2" Sq.
Height: 44"
Wt. 1.6 lbs.
TUBULAR

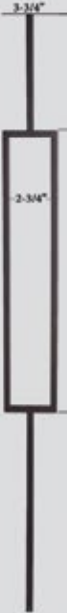

HF 16.6.3
Ends: 1/2" Sq.
Height: 44"
Wt. 1.7 lbs.
TUBULAR

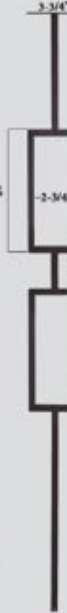

HF 16.6.4
Ends: 1/2" Sq.
Height: 44"
Wt. 1.7 lbs.
TUBULAR

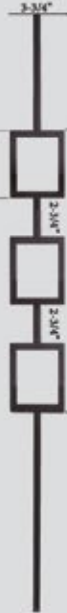

HF 16.6.5
Ends: 1/2" Sq.
Height: 44"
Wt. 1.8 lbs.
TUBULAR

NEW

Rake panels fit all angles up to 40 degrees

NEW



HF 9.4.1
Ends: 1/2" Sq.
Height: 44"
Wt. 4.4 lbs.
TUBULAR (Level)

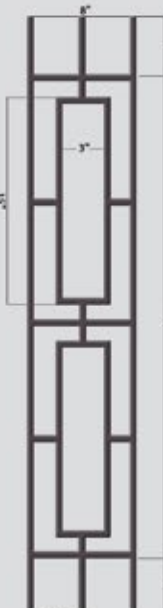

HF 9.4.2
Ends: 1/2" Sq.
Height: 44"
Wt. 4.8 lbs.
TUBULAR (Level)



HF 9.4.3
Ends: 1/2" Sq.
Height: 44"
Wt. 5 lbs.
TUBULAR (Level)



HF 9.4.4
Ends: 1/2" Sq.
Height: 44"
Wt. 5 lbs.
TUBULAR (Level)



HF 9.4.11
Ends: 1/2" Sq.
Height: 46"
Wt. 4.5 lbs.
TUBULAR (Rake)

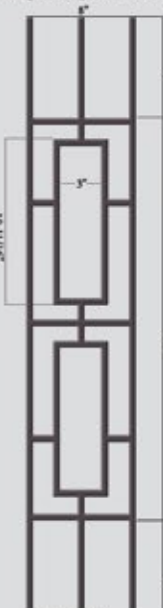

HF 9.4.22
Ends: 1/2" Sq.
Height: 46"
Wt. 4.7 lbs.
TUBULAR (Rake)

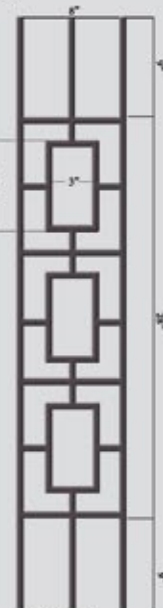

HF 9.4.33
Ends: 1/2" Sq.
Height: 46"
Wt. 4.9 lbs.
TUBULAR (Rake)



HF 9.4.44
Ends: 1/2" Sq.
Height: 46"
Wt. 4.9 lbs.
TUBULAR (Rake)



Satin Clear (shown)

The craftsmanship in these hand-forged balusters exude character and beauty nearly impossible to duplicate. Our Tuscan series is available in both round forged and square hammered profiles. Bring the rustic charm of old world Italy into your home with this unique series.

Oil Rubbed Bronze (shown)

TUSCAN



Vintage Brass (shown)



Oil Rubbed Bronze (shown)

TUSCAN

ROUND HAND FORGED



Finishes & Patinas

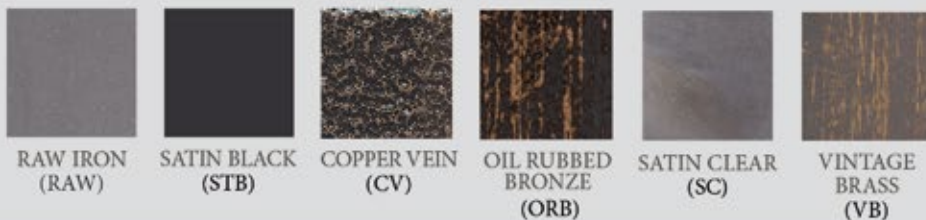

	NEWELS	HF1.1.22	HF1.1.8	HF1.1.9	HF1.1.16	HF1.1.20	HF1.1.21	BALUSTERS	HF2.9.21	HF2.1.5	HF2.1.6	HF2.1.7	HF2.1.9	HF2.1.8	HF2.1.11	HF2.6.8	HF2.6.9	HF2.6.7	HF2.10.2	HF2.10.4	HF2.10.3	HF2.11.40	HF2.11.41
RAW	•			•	•				•				•	•	•	•	•	•	•	•	•		
STB		•	•	•	•	•	•		•	•	•	•	•	•	•	•	•	•	•	•	•	•	•
CV					•				•											•	•	•	
ORB		•	•	•	•	•	•		•	•	•	•	•	•	•	•	•	•	•	•	•	•	•
SC		•			•		•		•							•	•	•	•	•	•		
VB					•	•			•										•	•	•	•	•

ACCESSORIES

- Level base shoes
- Level base collars
- Angled base shoes
- Adjustable level base shoes
- Adjustable angled base shoes
- Newel mounting kit

- HF16.3.26
- HF16.3.40, HF16.3.43
- HF16.3.27
- HF16.3.44, HF16.3.46
- HF16.3.45, HF16.3.47
- HF16.3.33

- Photos: J.
- Photos: K. O.
- Photos: N.
- Photos: R.
- Photos: S.
- Photos: U.

For photos and full accessory details see pages 52-53



NEWEL
47-1/4"
HF 1.1.22
Ends : 1" Rd.
Height: 47-1/4"
Wt. 18 lbs.

NEWEL
17-1/8"
5-3/8"
24-3/4"
HF 1.1.8
Ends : 1" Rd.
Height: 47-1/4"
Wt. 18 lbs.

NEWEL
18-1/8"
3"
26-1/8"
HF 1.1.9
Ends : 1" Rd.
Height: 47-1/4"
Wt. 18 lbs.

NEWEL
17-1/8"
5"
25-1/8"
HF 1.1.16
Ends : 1" Rd.
Height: 47-1/4"
Wt. 18 lbs.

NEWEL
14-13/16"
8-14/16"
24-3/16"
HF 1.1.20
Ends : 1" Rd.
Height: 47-1/4"
Wt. 18 lbs.

NEWEL
14-3/8"
2-3/4"
10-5/8"
22-1/4"
HF 1.1.21
Ends : 1" Rd.
Tapered
Height: 47-1/4"
Wt. 18 lbs.

NEWEL
17-1/2"
4-1/2"
22"
HF 2.1.5
Ends : 9/16" Rd.
Height: 44"
Wt. 2.5 lbs.

NEWEL
12-1/2"
14-1/2"
17"
HF 2.1.6
Ends : 9/16" Rd.
Height: 44"
Wt. 4.2 lbs.

NEWEL
9"
4-1/2"
11"
4-1/2"
15"
HF 2.1.7
Ends : 9/16" Rd.
Height: 44"
Wt. 3 lbs.



HF 2.1.9
 Ends : 9/16" Rd.
 Height: 44"
 Wt. 2.4 lbs.



HF 2.1.8
 Ends : 9/16" Rd.
 Height: 44"
 Wt. 4.2 lbs.



HF 2.1.11
 Ends : 9/16" Rd.
 Height: 44"
 Wt. 3 lbs.



HF 2.6.8
 Ends : 9/16" Rd.
 Tapered
 Height: 44"
 Wt. 3.2 lbs.



HF 2.6.9
 Ends : 9/16" Rd.
 Height: 44"
 Wt. 4.2 lbs.



HF 2.6.7
 Ends : 9/16" Rd.
 Tapered
 Height: 44"
 Wt. 3.8 lbs.



HF 2.9.21
 Ends : 9/16" Rd.
 Height: 44"
 Wt. 2.4 lbs.



HF 2.10.2
 Ends : 9/16" Rd.
 Height: 44"
 Wt. 3.2 lbs.



HF 2.10.4
 Ends : 9/16" Rd.
 Height: 44"
 Wt. 4.2 lbs.



HF 2.10.3
 Ends : 9/16" Rd.
 Height: 44"
 Wt. 3.6 lbs.



HF 2.11.40
 Ends : 9/16" Rd.
 Height: 44"
 Wt. 4 lbs.

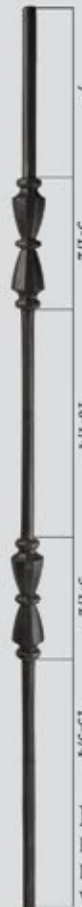

HF 2.11.41
 Ends : 9/16" Rd.
 Height: 44"
 Wt. 5.2 lbs.



Finishes & Patinas



RAW IRON
(RAW)



SATIN BLACK
(STB)



COPPER VEIN
(CV)



OIL RUBBED
BRONZE
(ORB)



SATIN CLEAR
(SC)



VINTAGE
BRASS
(VB)

	NEWELS	HF1.1.10	HF1.1.11	HF1.1.14	HF1.1.14-T	HF1.1.15	HF1.1.15-T	BALUSTERS	HF2.9.12	HF2.9.11	HF2.9.13	HF2.9.3	HF2.9.4	HF2.9.8	HF2.9.5	HF2.9.6	HF2.1.2	HF2.1.1	HF2.9.20	HF2.9.20-T	HF2.9.28	HF2.9.28-T	HF2.9.27	HF2.9.26	HF2.9.26-T	HF2.9.29	HF2.9.36	HF2.9.37
RAW		•	•	•		•			•	•	•	•	•	•	•	•			•		•		•	•				
STB		•	•	•	•	•	•		•	•	•	•	•	•	•	•	•	•	•	•	•	•	•	•	•	•	•	•
CV			•	•		•			•	•	•			•					•		•		•	•				
ORB		•	•	•	•	•	•		•	•	•	•	•	•	•	•	•	•	•	•	•	•	•	•	•	•	•	•
SC			•	•		•			•	•	•			•					•		•		•	•				
VB			•	•		•			•	•	•	•	•	•	•	•	•	•	•	•	•	•	•	•	•	•	•	•

ACCESSORIES

- Level base shoes
- Level base collars
- Angled base shoes
- Adjustable level base shoes
- Adjustable angled base shoes
- Newel mounting kit

- HF16.3.25
- HF16.3.41, HF16.3.42
- HF16.3.28
- HF16.3.44, HF16.3.46
- HF16.3.45, HF16.3.47
- HF16.3.31

- Photos: C.
- Photos: D. H.
- Photos: G.
- Photos: R.
- Photos: S.
- Photos: T.

For photos and full accessory details see pages 56-57



NEWEL

15-1/2"

8-1/2"

23-1/4"

HF 1.1.10
Ends : 1" Sq.
Tapered
Height: 47-1/4"
Wt. 18 lbs.

NEWEL

16-1/4"

7"

24"

HF 1.1.11
Ends : 1" Sq.
Tapered
Height: 47-1/4"
Wt. 18 lbs.

NEWEL

47-1/4"

HF 1.1.14
Ends : 1" Sq.
Height: 47-1/4"
Wt. 18 lbs.
SOLID

HF 1.1.14-T
Ends : 1" Sq.
Height: 47-1/4"
Wt. 2.30 lbs.
TUBULAR

NEWEL

17-1/8"

5"

25-1/8"

HF 1.1.15
Ends : 1" Sq.
Height: 47-1/4"
Wt. 18 lbs.
SOLID

HF 1.1.15-T
Ends : 1" Sq.
Height: 47-1/4"
Wt. 5.30 lbs.
TUBULAR

NEWEL

17-1/2"

4-1/2"

22"

HF 2.9.12
Ends : 9/16" Sq.
Tapered
Height: 44"
Wt. 3.8 lbs.

NEWEL

12-1/2"

14-1/2"

17"

HF 2.9.11
Ends : 9/16" Sq.
Height: 44"
Wt. 5 lbs.

NEWEL

10"

4-1/2"

10-1/2"

4-1/2"

14-1/2"

HF 2.9.13
Ends : 9/16" Sq.
Tapered
Height: 44"
Wt. 5.5 lbs.

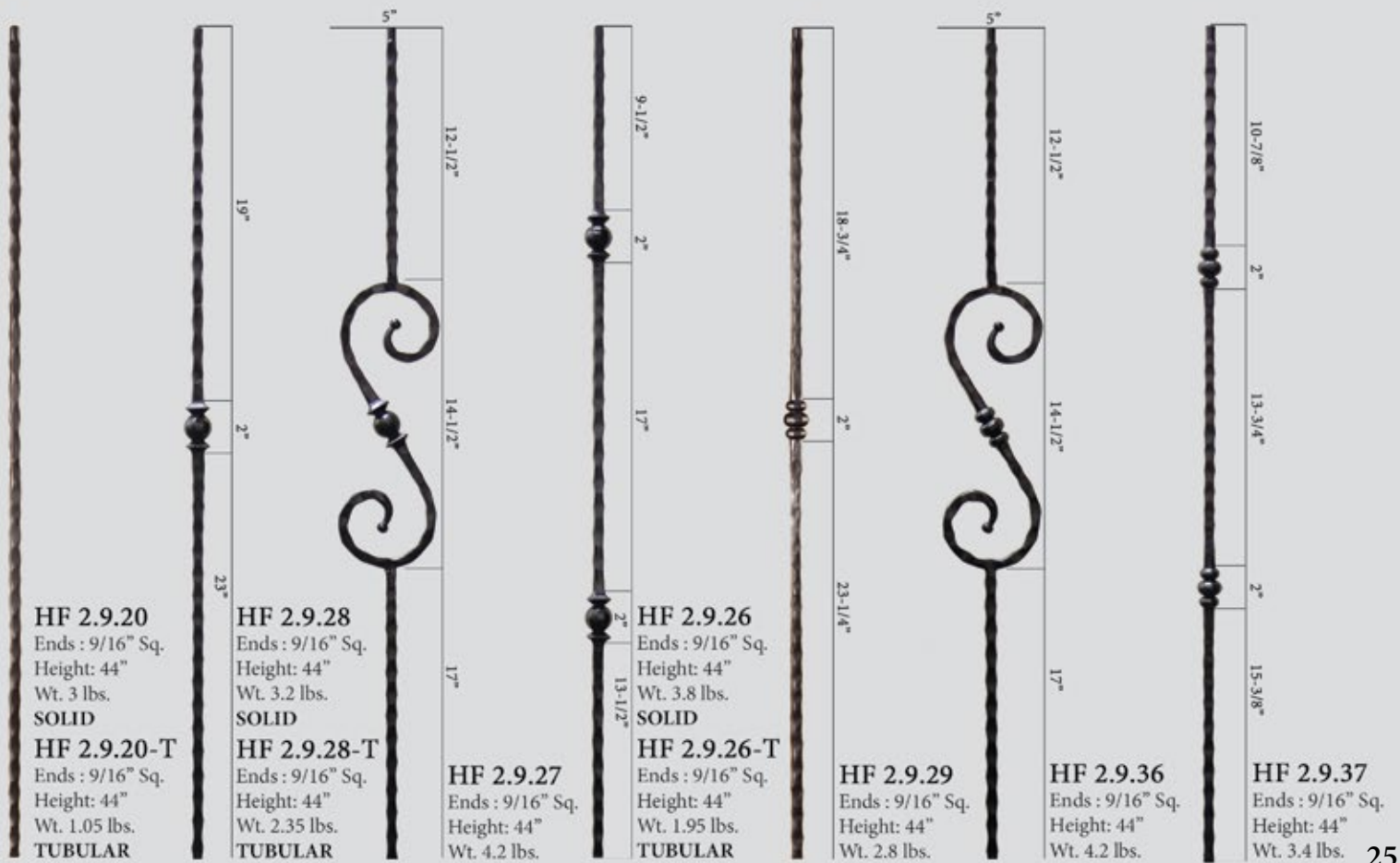
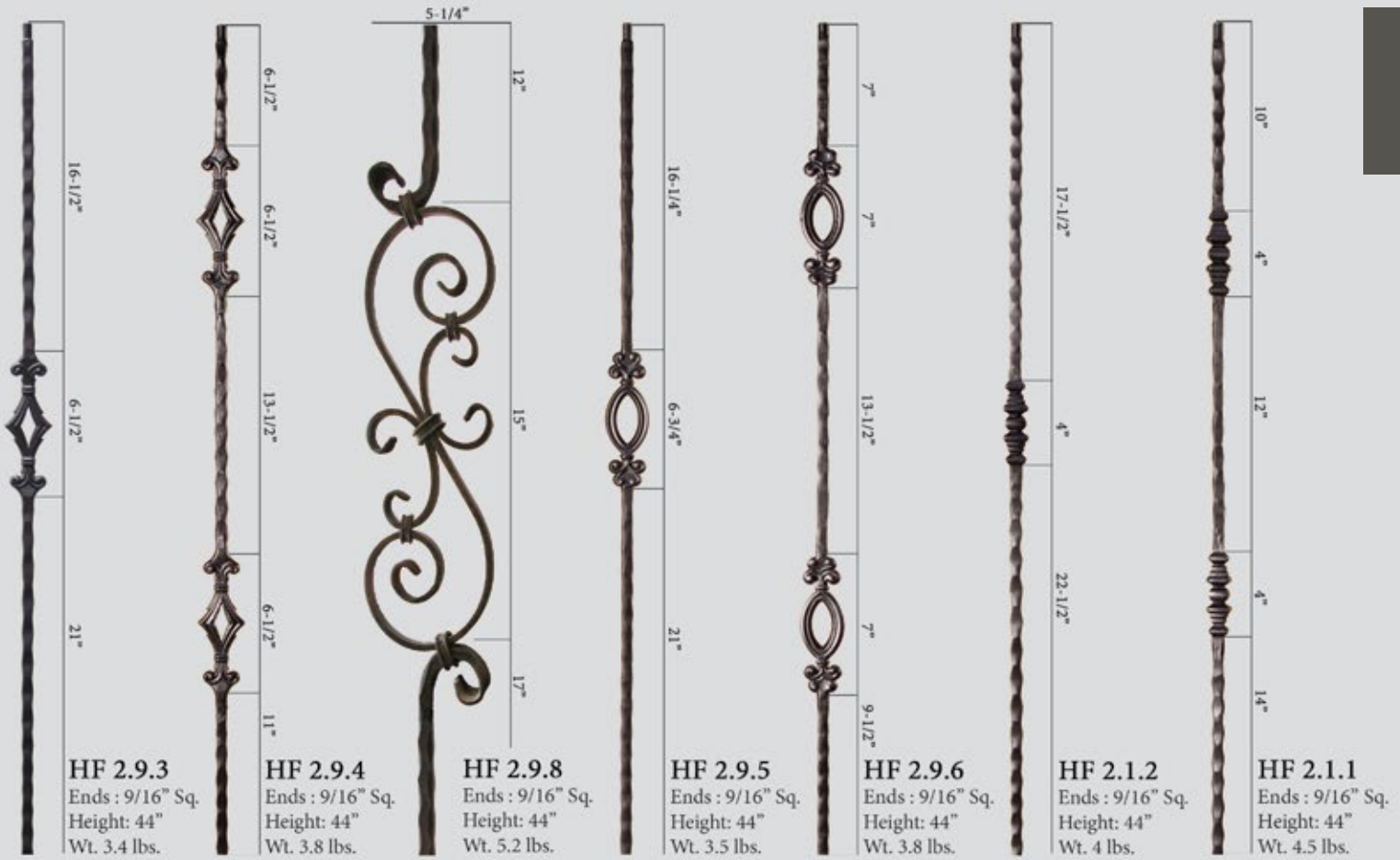

ORLEANS



Oil Rubbed Bronze (shown)

House of Forgings is pleased to feature our Orleans Series balusters which is a tribute to the renowned culture, customs and architecture of the great city of New Orleans. These exclusive designs are available with single or double elements and finished in Oil Rubbed Bronze and Vintage Brass patinas.

Orleans



Vintage Brass (shown)

Oil Rubbed Bronze (shown)

ORLEANS

SQUARE HAND HAMMERED



Finishes & Patinas



RAW IRON
(RAW)



OIL RUBBED
BRONZE
(ORB)



VINTAGE
BRASS
(VB)



NEWEL

47"

HF 1.1.14
Ends : 1" Sq.
Height: 47"
Wt. 18 lbs.



44"

HF 2.9.20
Ends : 9/16" Sq.
Height: 44"
Wt. 3 lbs.



12-1/2"

8-1/2"

23"

HF 2.9.23
Ends : 9/16" Sq.
Height: 44"
Wt. 3.5 lbs.



5-1/2"

8-1/2"

5-1/4"

8-1/2"

16-1/4"

HF 2.9.24
Ends : 9/16" Sq.
Height: 44"
Wt. 3.9 lbs.

ACCESSORIES

Level base shoes

Level base collars

Angled base shoes

Adjustable level base shoes

Adjustable angled base shoes

Newel mounting kit

HF16.3.25

HF16.3.41, HF16.3.42

HF16.3.28

HF16.3.44, HF16.3.46

HF16.3.45, HF16.3.47

HF16.3.31

Photos: C.

Photos: D. H.

Photos: G.

Photos: R.

Photos: S.

Photos: T.

For photos and full accessory details see pages 56-57



MONTE CARLO



Oil Rubbed Bronze (shown)

Drawing inspiration from the great Roman columns, the Monte Carlo series stands alone in style and elegance. The robust designs compliment the prominence of even the grandest estates. The intricately cast components are highlighted by the Oil Rubbed Bronze patina.

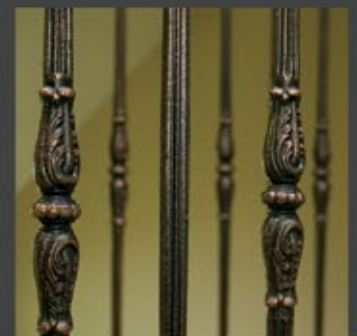

Oil Rubbed Bronze (shown)

MONTE CARLO

ROUND



Finishes & Patinas



*Middle section is hollow cast iron,
ends are hollow cast steel



*Middle section is hollow cast aluminum, ends are hollow cast steel



ACCESSORIES

Level base shoes
Angled base shoes
Newel mounting kit

HF16.3.50
HF16.3.51
HF16.3.14

Photos: I.
Photos: M.
Photos: U.

For photos and full accessory details see pages 56-57



ENDECOR



Vintage Brass (shown)

A House of Forgings exclusive, the Endecor® balustrade system has been featured by some of the top homebuilders in the nation. For the discerning client who wants to stand apart, these balusters are truly unique in form and function.

US D672,064 S
BALUSTER END PIECE



Satin Black (shown)



Additional U.S. and Canadian patents pending.

ENDECOR®

SQUARE



Finishes & Patinas



SATIN BLACK
(STB)



OIL RUBBED
BRONZE
(ORB)

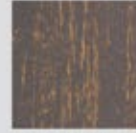

VINTAGE
BRASS
(VB)

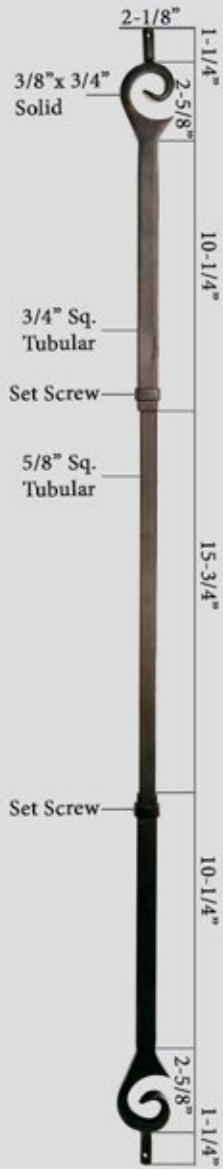

HF16.7.1

Ends : 9/16" Rd.
Height: 44"
Wt. 3.8 lbs.

US D708,356 S
BALUSTER END PIECE

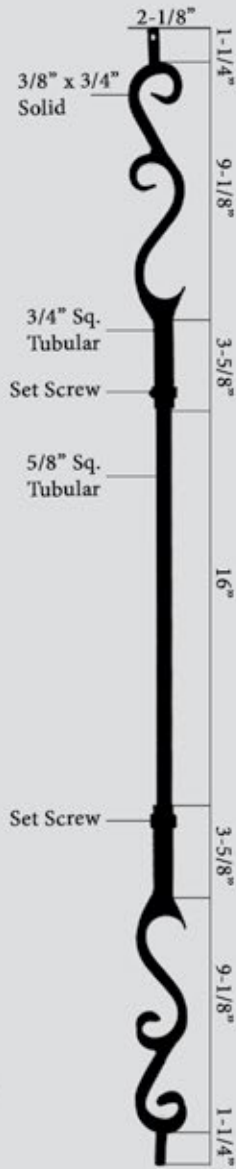

HF16.7.2

Ends : 9/16" Rd.
Height: 44"
Wt. 3.8 lbs.

US D708,355 S
BALUSTER END PIECE

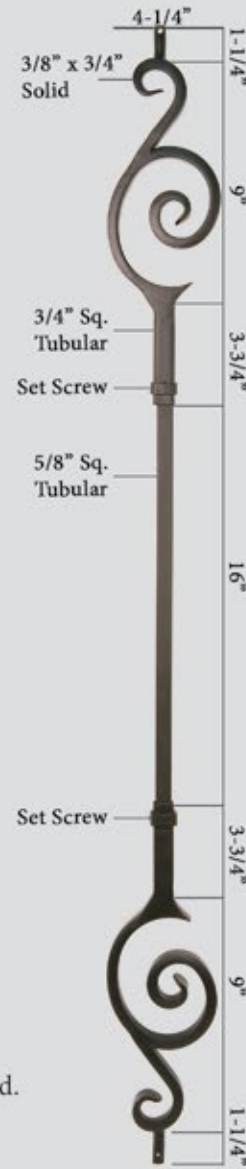

HF16.7.3

Ends : 9/16" Rd.
Height: 44"
Wt. 3.8 lbs.

US D672,064 S
BALUSTER END PIECE

Additional U.S and Canadian patents pending.

DESIGNER



Oil Rubbed Bronze (shown)

The designer series offers an upgraded look at an affordable price for homebuilders and homeowners alike. These hollow balusters are offered in square or round and compliment a wide range of architectural styles.

Oil Rubbed Bronze (shown)



Oil Rubbed Bronze (shown)

DESIGNER TUBULAR



Finishes & Patinas



HF 16.8.1
Ends : 5/8" Rd.
Height: 44"
Wt. 2 lbs.
TUBULAR



HF 16.8.2
Ends : 5/8" Rd.
Height: 44"
Wt. 2 lbs.
TUBULAR



HF 16.8.3
Ends : 5/8" Rd.
Height: 44"
Wt. 2 lbs.
TUBULAR



HF 16.8.4
Ends : 5/8" Rd.
Height: 44"
Wt. 3 lbs.
TUBULAR



HF 16.8.5
Ends : 5/8" Rd.
Height: 44"
Wt. 3 lbs.
TUBULAR



HF 16.8.6
Ends : 5/8" Sq.
Height: 44"
Wt. 2 lbs.
TUBULAR



HF 16.8.10
Ends : 5/8" Sq.
Height: 44"
Wt. 2 lbs.
TUBULAR



HF 16.8.11
Ends : 5/8" Sq.
Height: 44"
Wt. 2 lbs.
TUBULAR



HF 16.8.8
Ends : 5/8" Sq.
Height: 44"
Wt. 3 lbs.
TUBULAR



HF 16.8.9
Ends : 5/8" Sq.
Height: 44"
Wt. 4 lbs.
TUBULAR

ACCESSORIES

Level base shoes
Angled base shoes

HF16.3.35, HF16.3.38
HF16.3.36, HF16.3.39

Photos: J. C.
Photos: N. G.

For photos and full accessory details see pages 56-57



STAINLESS STEEL



Stainless steel is a mainstay in the modern and contemporary home decor market. The simple, honest lines of this profile is the perfect compliment to your urban dwelling. Now, offered in a more affordable tubular style for the budget savy buyer.

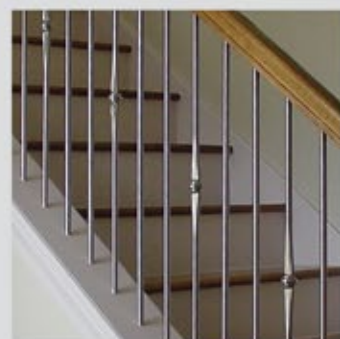

STAINLESS STEEL

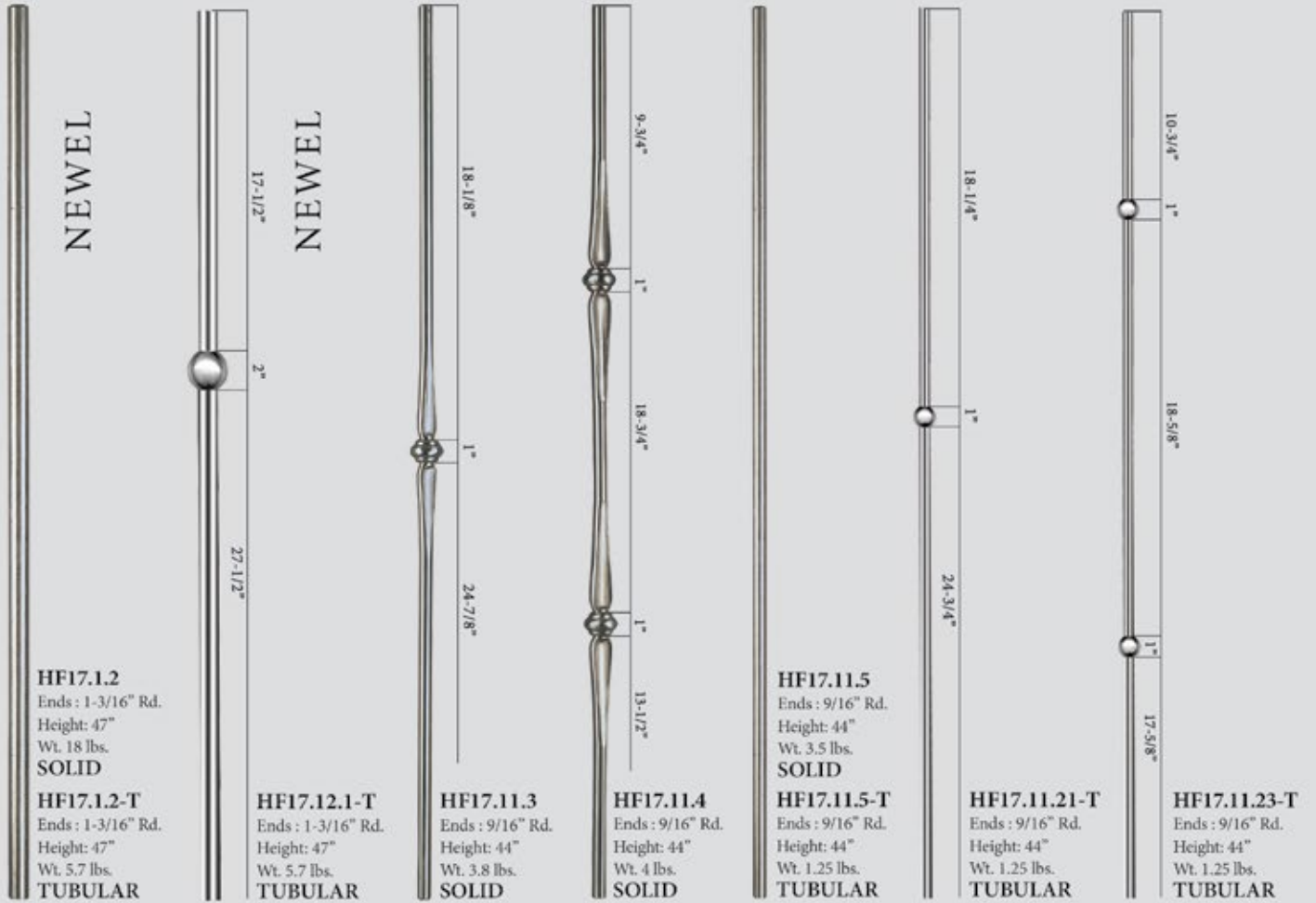

ACCESSORIES

Level base collar
Newel mounting kit

HF17.11.22
HF17.2.3

Photos: L.
Photos: V.

For photos and full accessory details see pages 56-57





SANTA FE

Satin Black (shown)

Our Santa Fe collection of edge hammered balusters are reminiscent of the old world Spanish architecture found in rustic Mexican villas. The bold, distinct hammering is the key to turning your home into an impressive estate.

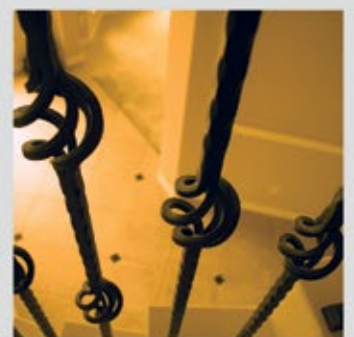

Satin Black (shown)

SANTA FE

SQUARE EDGE HAMMERED



Finishes & Patinas



HF 16.3.8
Ends : 9/16" Sq.
Height: 44"
Wt. 3.7 lbs.



HF 16.1.26
Ends : 9/16" Sq.
Height: 44"
Wt. 4 lbs.



HF 16.1.27
Ends : 9/16" Sq.
Height: 44"
Wt. 4.5 lbs.



HF 16.1.15
Ends : 9/16" Sq.
Height: 44"
Wt. 3 lbs.



HF 16.1.22
Ends : 9/16" Sq.
Height: 44"
Wt. 3.6 lbs.

ACCESSORIES

Level base shoes

Angled base shoes

Adjustable level base shoes

Adjustable angled base shoes

HF16.3.3

HF16.3.17

HF16.3.44, HF16.3.46

HF16.3.45, HF16.3.47

Photos: A.

Photos: E.

Photos: R.

Photos: S.

For photos and full accessory details see pages 56-57





GOTHIC

Oil Rubbed Copper (shown)

The inspiration for our Gothic series was the timeless ironwork featured in many European castles and estates. These prominent designs will compliment old world hardware and fixtures found throughout many homes today.

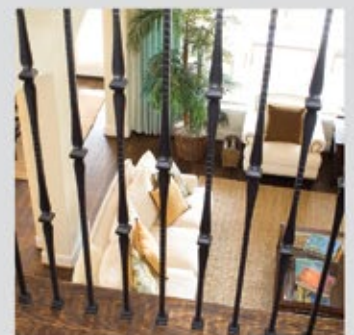

Oil Rubbed Copper (shown)

GOTHIC

SQUARE FACE HAMMERED



Finishes & Patinas



RAW IRON
(RAW)



SATIN BLACK
(STB)



COPPER VEIN
(CV)



OIL RUBBED
BRONZE
(ORB)



OIL RUBBED
COPPER
(ORC)



NEWEL

HF 16.5.6
Ends : 1-3/16" Sq.
Height: 48"
Wt. 22 lbs.



HF 16.1.7
Ends : 9/16" Sq.
Height: 44"
Wt. 4 lbs.



HF 16.5.2
Ends : 9/16" Sq.
Height: 44"
Wt. 3.5 lbs.



HF 16.1.8
Ends : 9/16" Sq.
Height: 44"
Wt. 3.8 lbs.



HF 16.1.9
Ends : 9/16" Sq.
Height: 44"
Wt. 4.5 lbs.

ACCESSORIES

Level base shoes

Level base collars

Angled base shoes

Adjustable level base shoes

Adjustable angled base shoes

Newel mounting kit

HF16.3.3, HF16.3.20, HF16.3.25

HF16.3.41, HF16.3.42

HF16.3.17, HF16.3.28

HF16.3.44, HF16.3.46

HF16.3.45, HF16.3.47

HF16.2.3

Photos: A. A. C.

Photos: D. H.

Photos: E. G.

Photos: R.

Photos: S.

Photos: T.

For photos and full accessory details see pages 56-57





Satin Black (shown)

The style of this collection provides a sleek appearance that strikes a perfect balance between traditional and contemporary.

Ash Grey (shown)

ROUND



Oil Rubbed Bronze/Dorado Gold/Satin Black (shown)

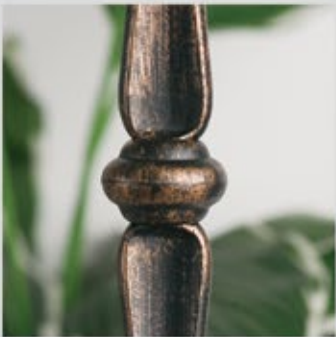

Oil Rubbed Bronze (shown)



Dorado Gold (shown)



Ash Grey/Satin Black (shown)

ROUND ROUND SMOOTH



Finishes & Patinas

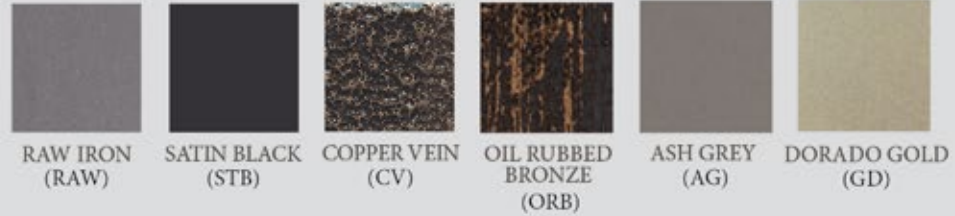

	NEWELS	HF16.5.10	HF16.5.11	HF16.5.11-T	HF1.1.19	BALUSTERS	HF16.2.2	HF16.1.17	HF16.1.18	HF16.1.19	HF16.1.20	HF16.1.25-R	HF2.11.3	HF2.11.3-T	HF2.11.4	HF2.11.4-T	HF2.11.16	HF2.11.16-T	HF2.8.18	HF16.8.1	HF16.8.12	HF16.8.13	HF16.8.14	
RAW			•		•							•	•	•	•	•	•	•	•	•				
STB		•	•	•	•		•	•	•	•	•	•	•	•	•	•	•	•	•		•	•	•	
CV		•	•				•	•	•	•	•	•												
ORB			•		•							•	•	•	•	•	•	•	•	•	•			
AG				•										•		•					•	•	•	
GD																								•



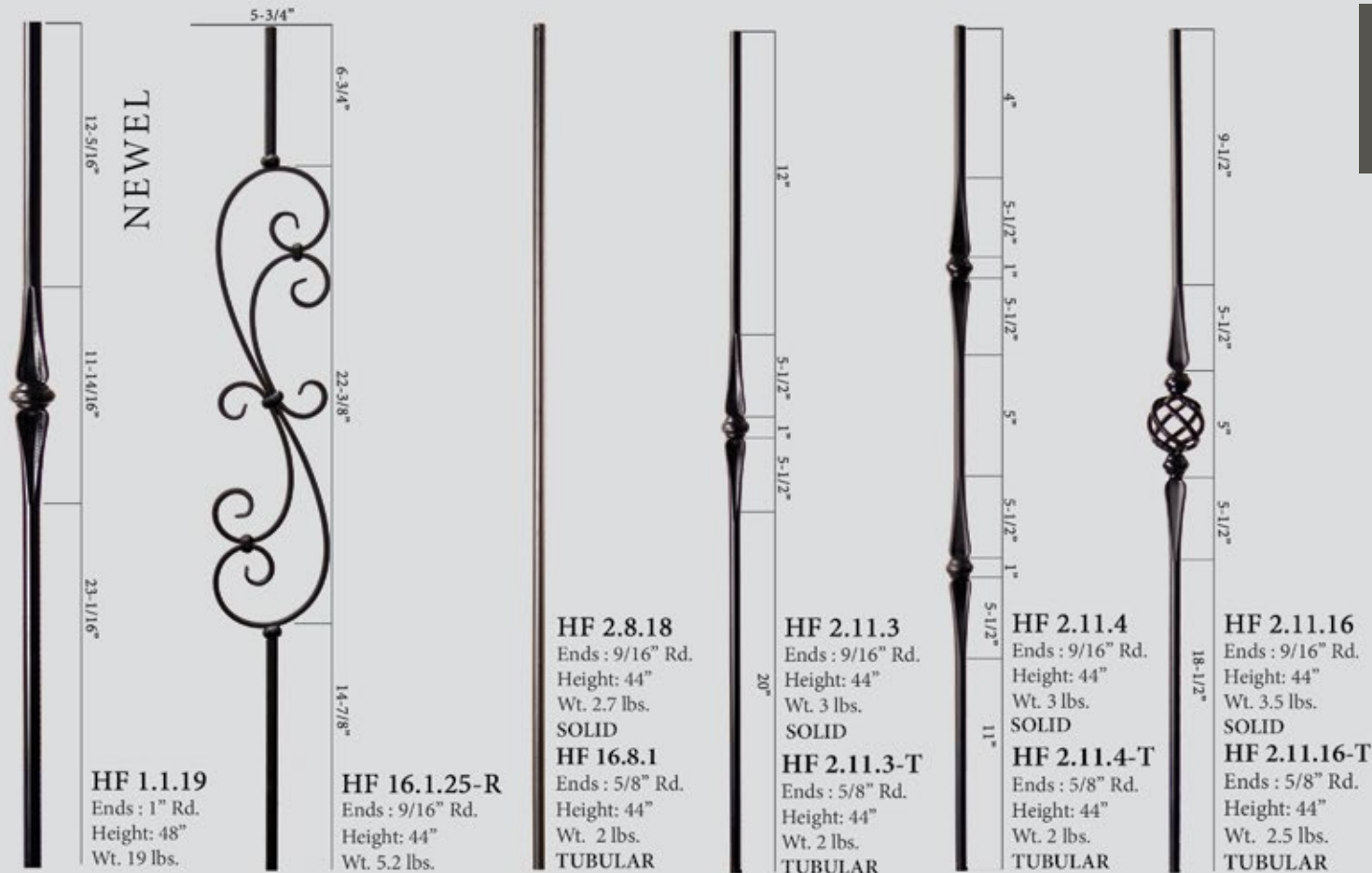

NEW



NEW



NEW

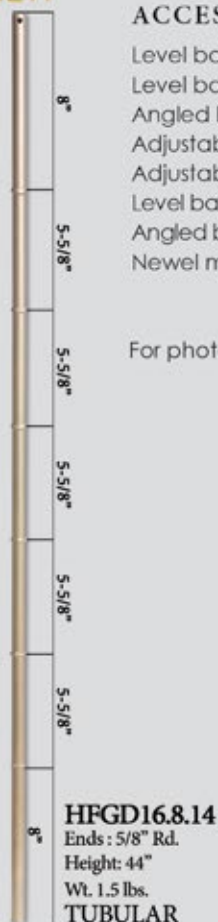

ACCESSORIES

- Level base shoes
- Level base collars
- Angled base shoes
- Adjustable level base shoes
- Adjustable angled base shoes
- Level base shoe, fits 5/8"
- Angled base shoe, fits 5/8"
- Newel mounting kit

- HF16.3.13, HF16.3.26, 16.3.50**
- HF16.3.40, HF16.3.43**
- HF16.3.16, HF16.3.27, 16.3.51**
- HF16.3.44, HF16.3.46**
- HF16.3.45, HF16.3.47**
- HF16.3.35**
- HF16.3.36**
- HF16.3.14, HF16.3.33**

- Photos: I. J.
- Photos: K. O.
- Photos: M. N.
- Photos: R.
- Photos: S.
- Photos: J.
- Photos: N.
- Photos: U.

For photos and full accessory details see pages 56-57





Ash Grey (shown)

The endless baluster combinations in this series offers a match for your individual taste and style. These balusters compliment our Scroll, Twist and Ribbon series.

Silver Vein (shown)

VERSATILE

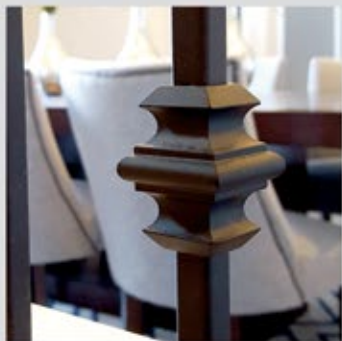

Satin Black (shown)



Oil Rubbed Bronze (shown)



VERSATILE SQUARE



Finishes & Patinas



	NEWELS	HF16.5.8	HF16.5.8-T	HF16.5.9	HF16.5.9-T	BALUSTERS	HF16.2.1	HF16.2.1-T	HF16.2.1-50	HF16.1.34	HF16.1.34-T	HF16.1.35	HF16.1.35-T	HF16.1.45	HF16.1.45-T	HF2.10.1	HF2.2.3	HF16.1.25	HF16.1.25-T	HF16.1.25-S	
RAW		•		•			•	•		•	•	•	•				•	•	•		
STB		•		•			•	•	•	•	•	•	•	•	•		•	•	•	•	•
AG			•		•			•			•		•							•	
SP		•		•			•	•		•	•	•	•	•					•	•	
CV		•		•			•	•		•	•	•	•	•	•				•	•	
ORB		•		•			•	•		•	•	•	•	•					•	•	•
ORC		•		•			•	•		•	•	•	•	•	•				•	•	•
AN		•		•			•			•		•		•				•			

NEWEL

NEWEL

HF 16.5.8
Ends : 1-3/16" Sq.
Height: 48"
Wt. 19 lbs.
SOLID

HF 16.5.8-T
Ends : 1-3/16" Sq.
Height: 48"
Wt. 4.8 lbs.
TUBULAR

HF 16.5.9
Ends : 1-3/16" Sq.
Height: 48"
Wt. 20 lbs.
SOLID

HF 16.5.9-T
Ends : 1-3/16" Sq.
Height: 48"
Wt. 9.7 lbs.
TUBULAR

HF 16.2.1
Ends : 1/2" Sq.
Height: 44"
Wt. 3 lbs.
SOLID

HF 16.2.1-T
Ends : 1/2" Sq.
Height: 44"
Wt. 1.2 lbs.
TUBULAR

HF 16.2.1-50
Ends : 1/2" Sq.
Height: 50"
Wt. 3.2 lbs.
SOLID

HF 16.1.34
Ends : 1/2" Sq.
Height: 44"
Wt. 4 lbs.
SOLID

HF 16.1.34-T
Ends : 1/2" Sq.
Height: 44"
Wt. 1.35 lbs.
TUBULAR

HF 16.1.35
Ends : 1/2" Sq.
Height: 44"
Wt. 3.5 lbs.
SOLID

HF 16.1.35-T
Ends : 1/2" Sq.
Height: 44"
Wt. 1.5 lbs.
TUBULAR

HF 16.1.45
Ends : 1/2" Sq.
Height: 44"
Wt. 4 lbs.
SOLID

HF 16.1.45-T
Ends : 1/2" Sq.
Height: 44"
Wt. 1.55 lbs.
TUBULAR



HF 2.10.1
 Ends : 1/2" Sq.
 Height: 44"
 Wt. 4.2 lbs.



HF 2.2.3
 Ends : 1/2" Sq.
 Height: 44"
 Wt. 3 lbs.



HF 16.1.25
 Ends : 1/2" Sq.
 Height: 44"
 Wt. 5.2 lbs.
SOLID

HF 16.1.25-T
 Ends : 1/2" Sq.
 Height: 44"
 Wt. 3.85 lbs.
TUBULAR



HF 16.1.25-S
 Ends : 1/2" Sq.
 Height: 44"
 Wt. 5.2 lbs.

ACCESSORIES

- Level base shoes **HF16.3.1, HF16.3.19, HF16.3.29**
- Level base collars **HF16.3.4, HF16.3.5,**
- Angled base shoes **HF16.3.2, HF16.3.30**
- Adjustable level base shoes **HF16.3.44, HF16.3.46**
- Adjustable angled base shoes **HF16.3.45, HF16.3.47**
- Versatile style knuckle **HF16.5.1**
- Newel mounting kit **HF16.2.3**

- Photos: A. A. C.
- Photos: D. H.
- Photos: E. G.
- Photos: R.
- Photos: S.
- Photos: F.
- Photos: T.

For photos and full accessory details see pages 56-57 



Satin Black (shown)

The ribbon style twist in this series pairs nicely with balusters from the Scroll and Versatile series. The ribbon is accented nicely by the Oil Rubbed Bronze patina as well as the Copper Vein finish.

Copper Vein (shown)

RIBBON



RIBBON SQUARE



Finishes & Patinas



RAW IRON (RAW)

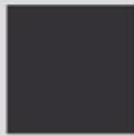

SATIN BLACK (STB)



COPPER VEIN (CV)



OIL RUBBED BRONZE (ORB)



OIL RUBBED COPPER (ORC)

	NEWELS	HF16.5.7	BALUSTERS	HF16.1.5	HF16.1.6	HF16.3.6	HF16.3.7	HF16.1.10	HF16.1.11
RAW		•		•	•				
STB		•		•	•	•	•	•	•
CV		•		•	•	•	•	•	•
ORB		•		•	•	•	•	•	•
ORC		•		•	•	•	•	•	•





HF 16.1.10
 Ends : 1/2" Sq.
 Height: 44"
 Wt. 3.6 lbs.



HF 16.1.11
 Ends : 1/2" Sq.
 Height: 44"
 Wt. 4.1 lbs.

ACCESSORIES

- Level base shoes
- Level base collars
- Angled base shoes
- Adjustable level base shoes
- Adjustable angled base shoes
- Versatile style knuckle
- Newel mounting kit

- HF16.3.1, HF16.3.19, HF16.3.29**
- HF16.3.4, HF16.3.5,**
- HF16.3.2, HF16.3.30**
- HF16.3.44, HF16.3.46**
- HF16.3.45, HF16.3.47**
- HF16.5.1**
- HF16.2.3**

- Photos: A. A. C.
- Photos: D. H.
- Photos: E. G.
- Photos: R.
- Photos: S.
- Photos: F.
- Photos: T.

For photos and full accessory details see pages 56-57





TWIST

Satin Black (shown)

This popular twist and basket design is a mainstay featured in many new homes. These balusters and newels are offered in an extensive range of finishes and patinas. They combine seamlessly with profiles from the Scroll and Versatile series.

Oil Rubbed Copper (shown)



Satin Black (shown)

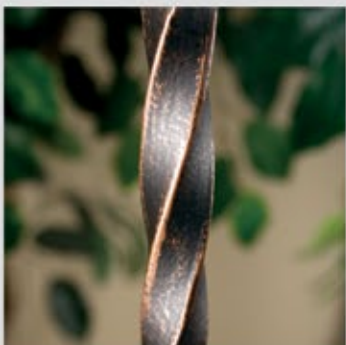

Oil Rubbed Bronze (shown)



Antique Nickel (shown)

TWIST SQUARE



Finishes & Patinas



	NEWELS	HF16.5.4	HF16.5.4-T	HF16.5.5	HF16.5.5-T	BALUSTERS	HF16.1.1	HF16.1.1-T	HF16.1.2	HF16.1.2-T	HF16.1.3	HF16.1.3-T	HF16.1.4	HF16.1.4-T	HF16.1.21	HF16.1.21-T	HF16.1.16	HF16.2.4	HF16.2.5	HF16.2.6	HF16.1.41	
RAW		•		•			•	•	•	•	•	•	•	•	•	•		•	•	•		
STB		•		•			•	•	•	•	•	•	•	•	•	•		•	•	•		•
AG			•		•			•		•		•		•		•						
SP		•		•			•	•	•	•	•	•	•	•	•	•						
CV		•		•			•	•	•	•	•	•	•	•	•	•						
ORB		•		•			•	•	•	•	•	•	•	•	•	•						
ORC		•		•			•	•	•	•	•	•	•	•	•	•						
AN		•		•			•		•		•		•		•		•					



NEWEL

13-1/4"

11-1/2"

23-1/4"

HF 16.5.4
Ends : 1-3/16" Sq.
Height: 48"
Wt. 18 lbs.
SOLID

HF 16.5.4-T
Ends : 1-3/16" Sq.
Height: 48"
Wt. 5.5 lbs.
TUBULAR

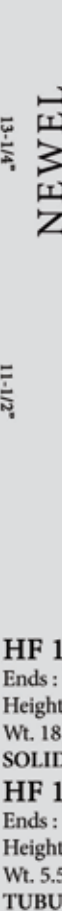

NEWEL

5-1/2"

7-1/4"

3-1/2"

6-1/2"

3-1/2"

7-1/4"

14-1/2"

HF 16.5.5
Ends : 1-3/16" Sq.
Height: 48"
Wt. 20 lbs.
SOLID

HF 16.5.5-T
Ends : 1-3/16" Sq.
Height: 48"
Wt. 7.6 lbs.
TUBULAR

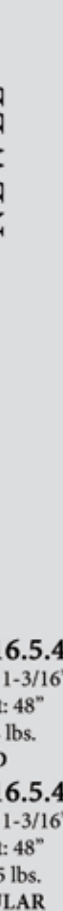

15"

6"

23"

HF 16.1.1
Ends : 1/2" Sq.
Height: 44"
Wt. 3 lbs.
SOLID

HF 16.1.1-T
Ends : 1/2" Sq.
Height: 44"
Wt. 1.2 lbs.
TUBULAR



9"

6"

6"

6"

6"

17"

HF 16.1.2
Ends : 1/2" Sq.
Height: 44"
Wt. 3 lbs.
SOLID

HF 16.1.2-T
Ends : 1/2" Sq.
Height: 44"
Wt. 1.15 lbs.
TUBULAR



6"

6"

3"

5-1/2"

3-1/2"

6"

14"

HF 16.1.3
Ends : 1/2" Sq.
Height: 44"
Wt. 4 lbs.
SOLID

HF 16.1.3-T
Ends : 1/2" Sq.
Height: 44"
Wt. 1.55 lbs.
TUBULAR

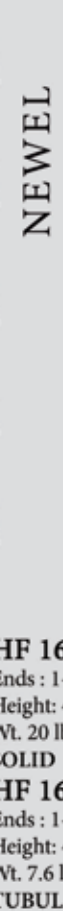

8"

5-1/2"

8"

5-1/2"

17"

HF 16.1.4
Ends : 1/2" Sq.
Height: 44"
Wt. 4 lbs.
SOLID

HF 16.1.4-T
Ends : 1/2" Sq.
Height: 44"
Wt. 1.95 lbs.
TUBULAR

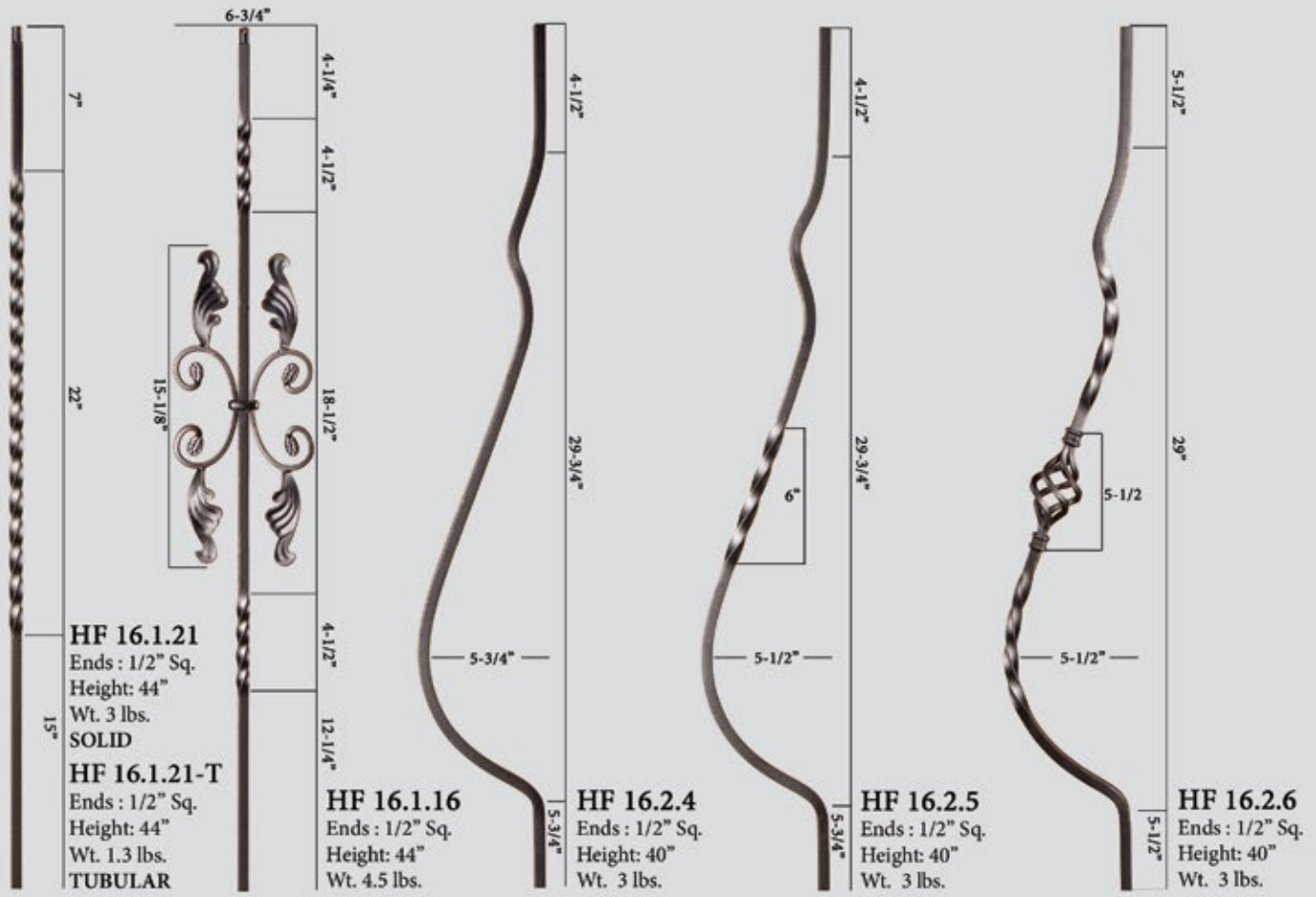

ACCESSORIES

- Level base shoes
- Level base collars
- Angled base shoes
- Adjustable level base shoes
- Adjustable angled base shoes
- Versatile style knuckle
- Newel mounting kit

- HF16.3.1, HF16.3.19, HF16.3.29**
- HF16.3.4, HF16.3.5,**
- HF16.3.2, HF16.3.30**
- HF16.3.44, HF16.3.46**
- HF16.3.45, HF16.3.47**
- HF16.5.1**
- HF16.2.3**

Photos: A. A. C.
Photos: D. H.
Photos: E. G.
Photos: R.
Photos: S.
Photos: F.
Photos: T.

For photos and full accessory details see pages 56-57 

ACCESSORY SPECIFICATIONS

Photo	Part #	Description	RAW	STB	AG	SP	CV	ORB	ORC	AN	VB	SC	GD
1/2" Square Baluster Accessories													
A.	HF16.3.1	Level base shoe, fits 1/2" square balusters, 1-5/16" square base, aluminum		•		•	•		•	•			
A.	HF16.3.19	Level base shoe with set screw, fits 1/2" square balusters, 1-5/16" square base, aluminum	•	•	•	•	•	•	•	•			•
E.	HF16.3.2	Angled base shoe with set screw, fits 1/2" square balusters, 1-5/16" base, aluminum	•	•	•	•	•	•	•	•			•
B.	HF16.3.21	Level base shoe with screw mount, fits 1/2" square balusters, 1-9/16" square base, aluminum		•			•						
F.	HF16.5.1	Versatile style knuckle with set screw, fits 1/2" square balusters, 1-7/16" square, aluminum	•	•		•	•	•	•	•			
C.	HF16.3.29	Oil Rubbed Bronze, level base shoe with set screw, fits 1/2" square balusters, 1-1/4" square base, cast iron		•				•					
G.	HF16.3.30	Oil Rubbed Bronze, angled base shoe with set screw, fits 1/2" square balusters, 1-1/4" base, cast iron						•					
D.	HF16.3.4	Level base collar, fits 1/2" square balusters, 2" square base, aluminum, (ORB - cast iron)		•			•	•	•				
H.	HF16.3.5	Level base collar, fits 1/2" square balusters, 1-15/16" round base, aluminum, (ORB - cast iron)		•			•	•	•				
9/16" Square Baluster Accessories													
A.	HF16.3.3	Level base shoe, fits 9/16" square balusters, 1-5/16" square base, aluminum		•			•		•				
A.	HF16.3.20	Level base shoe with set screw, fits 9/16" square balusters, 1-5/16" square base, aluminum		•			•	•	•				
E.	HF16.3.17	Angled base shoe with set screw, fits 9/16" square balusters, 1-5/16" base, aluminum		•			•	•	•				
C.	HF16.3.25	Level base shoe with set screw, fits 9/16" Tuscan square balusters, 1-1/4" square base, cast iron	•	•			•	•			•	•	
G.	HF16.3.28	Angled base shoe with set screw, fits 9/16" Tuscan square balusters, 1-1/4" base, cast iron	•	•			•	•			•	•	
D.	HF16.3.41	Level base collar, fits 9/16" square balusters, 2" square base, cast iron		•			•	•					
H.	HF16.3.42	Level base collar, fits 9/16" square balusters, 1-15/16" round base, cast iron		•				•			•		
5/8" Square Baluster Accessories													
C.	HF16.3.38	Level base shoe with set screw, fits 5/8" square balusters, 1-1/4" square base, cast iron		•				•				•	
G.	HF16.3.39	Angled base shoe with set screw, fits 5/8" square balusters, 1-1/4" base, cast iron		•				•				•	
9/16" Round Baluster Accessories													
I.	HF16.3.13	Level base shoe, fits 9/16" round balusters, 1-5/16" square base, aluminum		•			•						
M.	HF16.3.16	Angled base shoe with set screw, fits 9/16" round balusters, 1-5/16" base, aluminum		•			•						
J.	HF16.3.26	Level base shoe with set screw, fits 9/16" round balusters, 1-1/4" square base, cast iron		•			•	•			•	•	
N.	HF16.3.27	Angled base shoe with set screw, fits 9/16" round balusters, 1-1/4" base, cast iron		•			•	•			•	•	
K.	HF16.3.40	Level base collar, fits 9/16" round balusters, 2" square base, cast iron		•			•	•					
O.	HF16.3.43	Level base collar, fits 9/16" round balusters, 1-15/16" round base, cast iron		•				•			•		
L.	HF17.11.22	Level base collar, fits 9/16" round stainless steel balusters, 1-1/2" round base, stainless steel											
5/8" Round Baluster Accessories													
J.	HF16.3.35	Level base shoe with set screw, fits 5/8" round balusters, 1-1/4" square base, cast iron		•	•			•				•	
N.	HF16.3.36	Angled base shoe with set screw, fits 5/8" round balusters, 1-1/4" base, cast iron		•	•			•				•	
I.	HF16.3.50	Level base shoe with set screw, fits 5/8" round balusters, 1-5/16" square base, aluminum		•				•					
M.	HF16.3.51	Angled base shoe with set screw, fits 5/8" round balusters, 1-5/16" base, aluminum		•				•					
Adjustable Shoes/Collars have a flexible insert that allows them to be used with either square or round balusters ranging in size from 1/2" to 9/16". Epoxy must be used to permanently secure.													
R.	HF16.3.44	Level base shoe, fits 1/2" - 9/16" square or round balusters, 1-5/16" square base, cast iron		•			•	•			•	•	
R.	HF16.3.46	Level base shoe, fits 1/2" - 9/16" square or round balusters, 1-1/2" square base, cast iron		•			•	•			•	•	
S.	HF16.3.45	Angled base shoe, fits 1/2" - 9/16" square or round balusters, 1-5/16" base, cast iron		•			•	•			•	•	
S.	HF16.3.47	Angled base shoe, fits 1/2" - 9/16" square or round balusters, 1-1/2" base, cast iron		•			•	•			•	•	
P.	HF16.3.24	Level base collar, fits 1/2" - 9/16" square or round balusters, 1-11/16" square base, aluminum		•									
Q.	HF16.3.23	Level base collar, fits 1/2" - 9/16" square or round balusters, 1-11/16" round base, aluminum		•									
Newel Mounting Kits													
T.	HF16.2.3	Newel mounting kit with level base shoe, fits 1-3/16" square newels, 3-1/8" square base, cast iron	•	•	•	•	•	•	•	•			•
T.	HF16.3.31	Newel mounting kit with level base shoe, fits 1" square newels, 3-1/8" square base, cast iron	•	•			•	•			•	•	
U.	HF16.3.14	Newel mounting kit with level base shoe, fits 1-3/16" round newels, 3-1/8" square base, cast iron	•	•			•				•	•	
U.	HF16.3.33	Newel mounting kit with level base shoe, fits 1" round newels, 3-1/8" square base, cast iron	•	•	•		•	•			•	•	
V.	HF17.2.3	Newel mounting kit with level base collar, fits 1-3/16" round stainless steel newels, 3-1/4" round base, stainless steel											
Handrail Brackets													
W.	HF3002	Handrail bracket, 1-1/4" x 2-3/8" mounting plate, extends out 3" from wall, aluminum Also available in Brushed Chrome HFBC3002, Polished Brass HFPC3002		•	•	•	•	•	•			•	
X.	HF3003	Handrail bracket, 2-1/16" round mounting plate, extends out 3" from wall, aluminum Also available in Chrome HFCE3003, Brushed Chrome HFBC3003, Nickel HFNL3003		•	•	•	•	•	•	•	•	•	

ACCESSORY PROFILES



Forged Panels

**House of Forgings
is dedicated to
providing superior
products that meet the
highest standards of
architects,
homebuilders
and homeowners.**

We are pleased to provide a full line of prefabricated ornamental iron components. These elegant products allow for the look and feel of a fully custom fabricated iron stair or railing system. In addition to cost savings, installation time is greatly reduced compared to traditional fabrication.

STAIR & RAILING PRODUCTS BY





Rebecca panels paired with Monte Carlo balusters (shown)

REBECCA



Rebecca HFRB.B1 (shown)

5/8" ROUND IRON



1/2" ROUND IRON

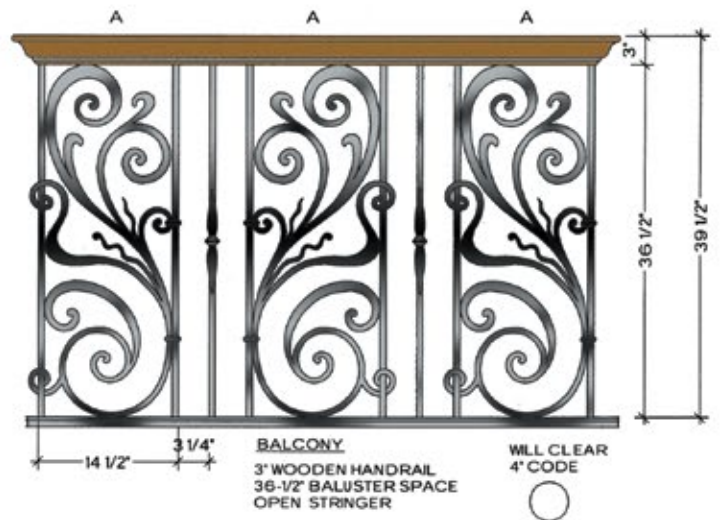
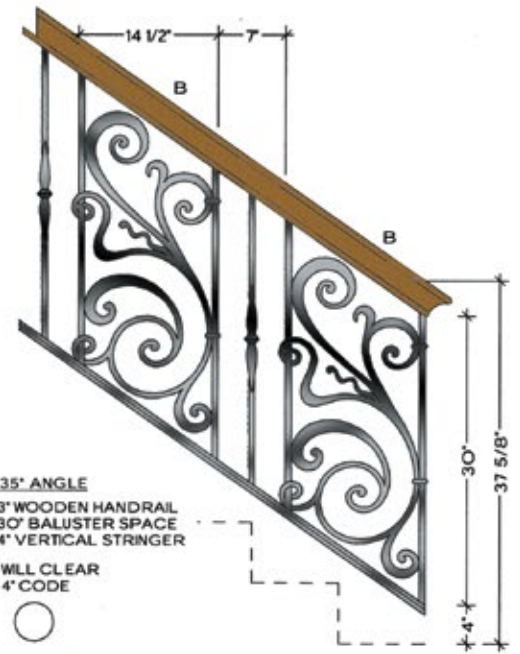

REBECCA

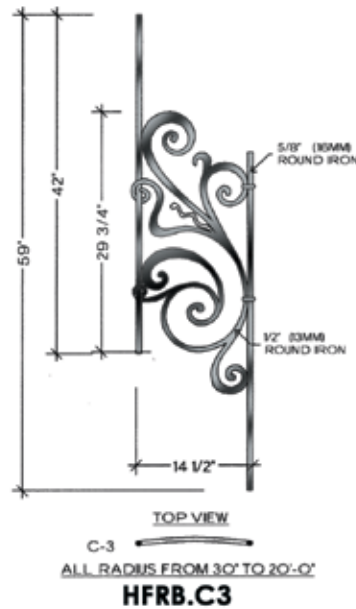
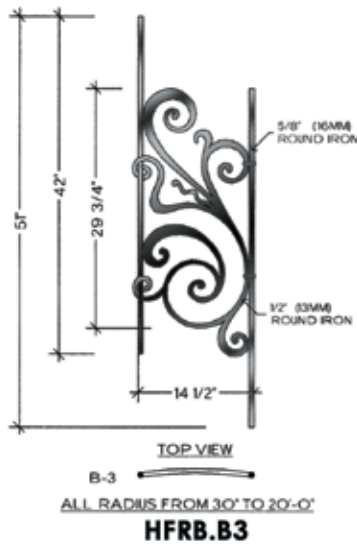
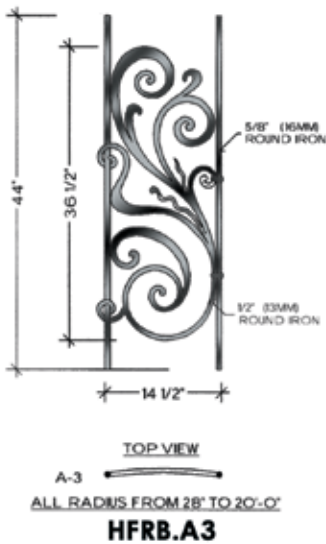
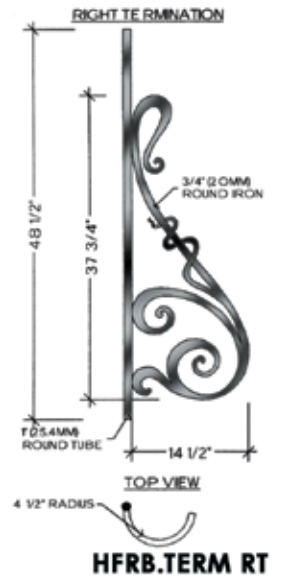
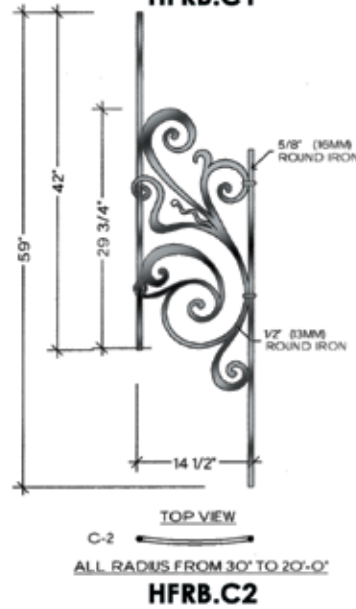
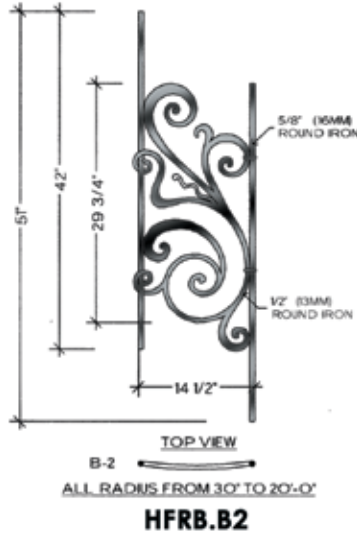
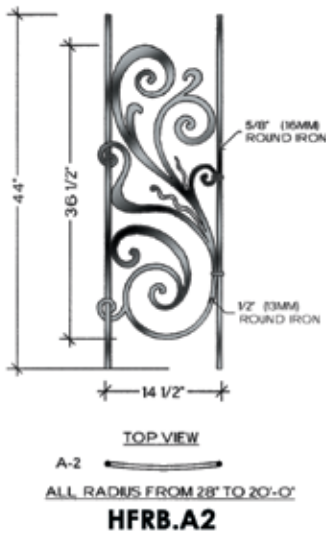
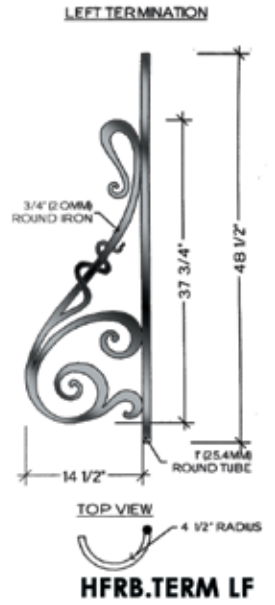
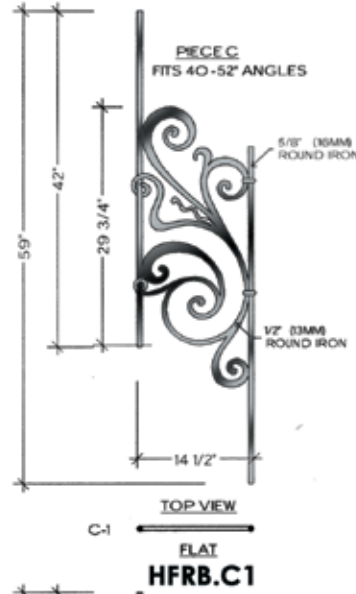
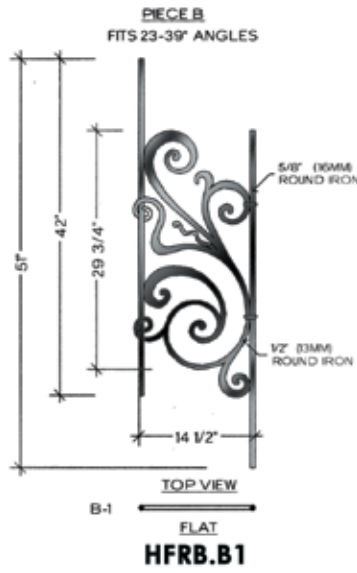
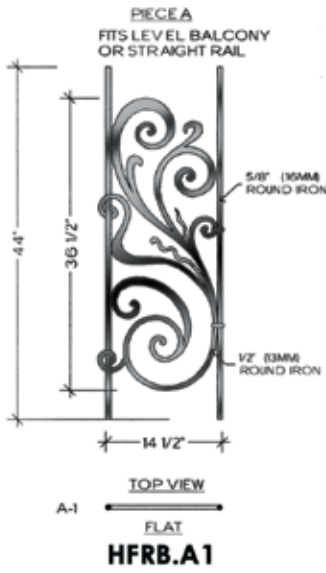

TUSCANY



Tuscany HFTU.A1 (shown)

1/2" SQUARE
IRON

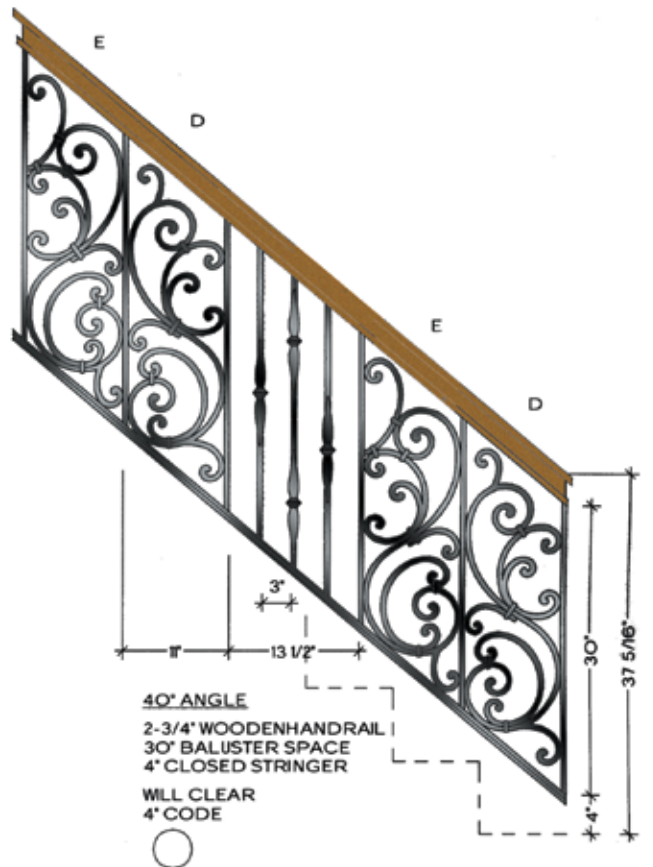
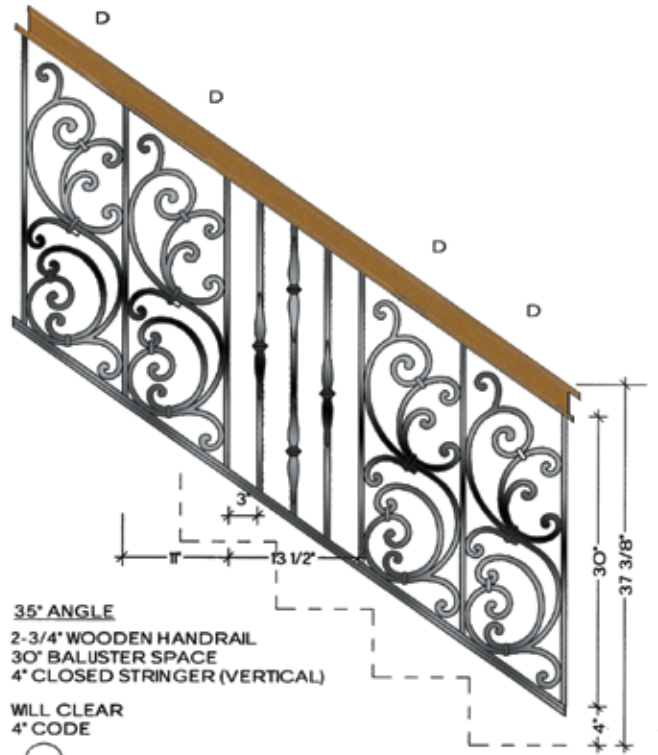

TUSCANY

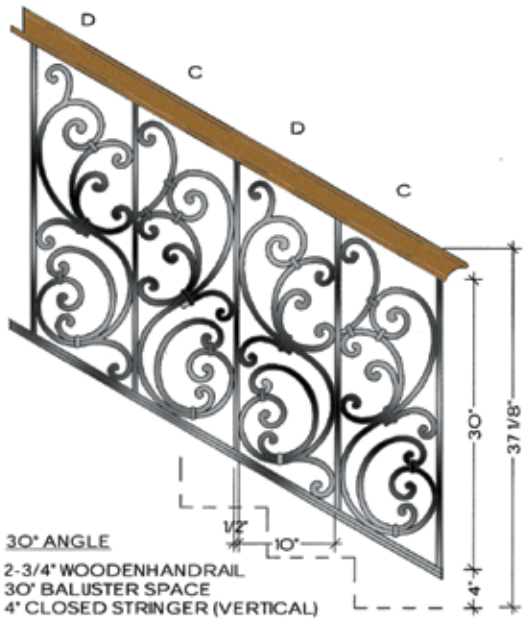

30° ANGLE
 2-3/4" WOODEN HANDRAIL
 30" BALUSTER SPACE
 4" CLOSED STRINGER (VERTICAL)

WILL CLEAR
 4" CODE

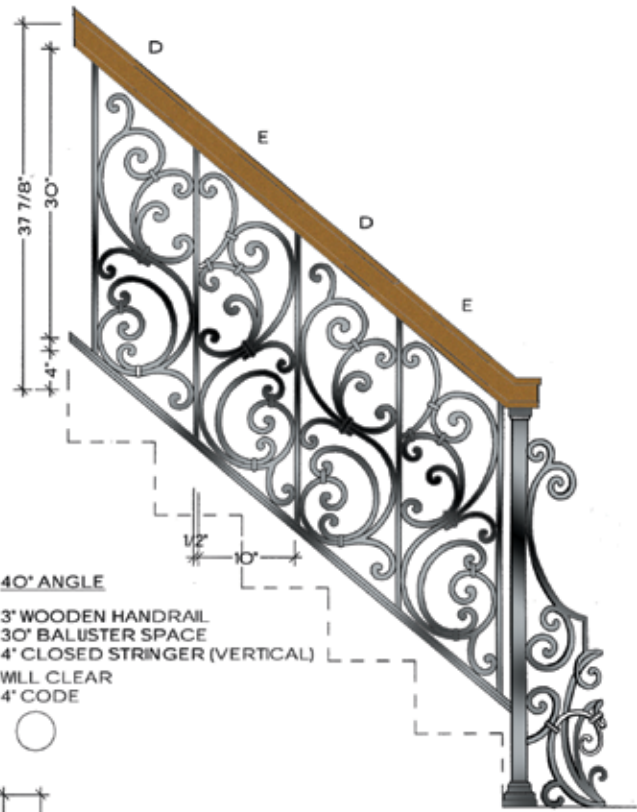

40° ANGLE
 3" WOODEN HANDRAIL
 30" BALUSTER SPACE
 4" CLOSED STRINGER (VERTICAL)

WILL CLEAR
 4" CODE



RIGHT TERMINATION
 LEFT SIDE VIEW



1/2" 10"

BALCONY
 3" WOODEN HANDRAIL
 33" BALUSTER SPACE

WILL CLEAR
 4" CODE

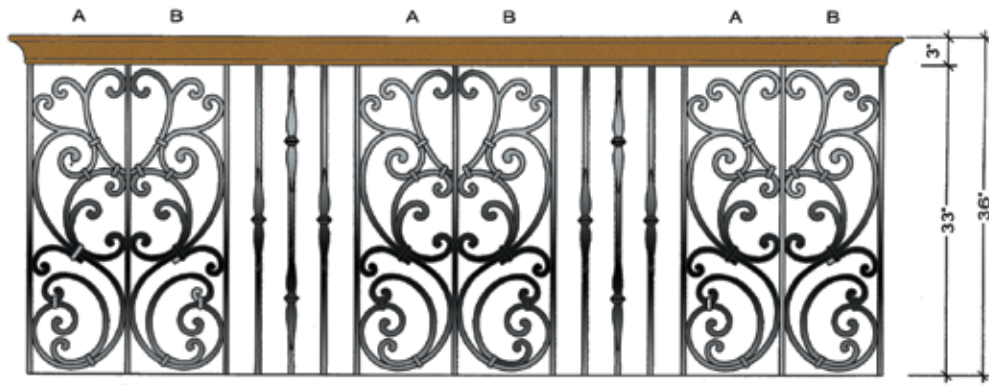

1/2" 10" 1/2" 3" 14 1/2"

BALCONY
 3" WOODEN HANDRAIL
 33" BALUSTER SPACE

WILL CLEAR
 4" CODE



TUSCANY

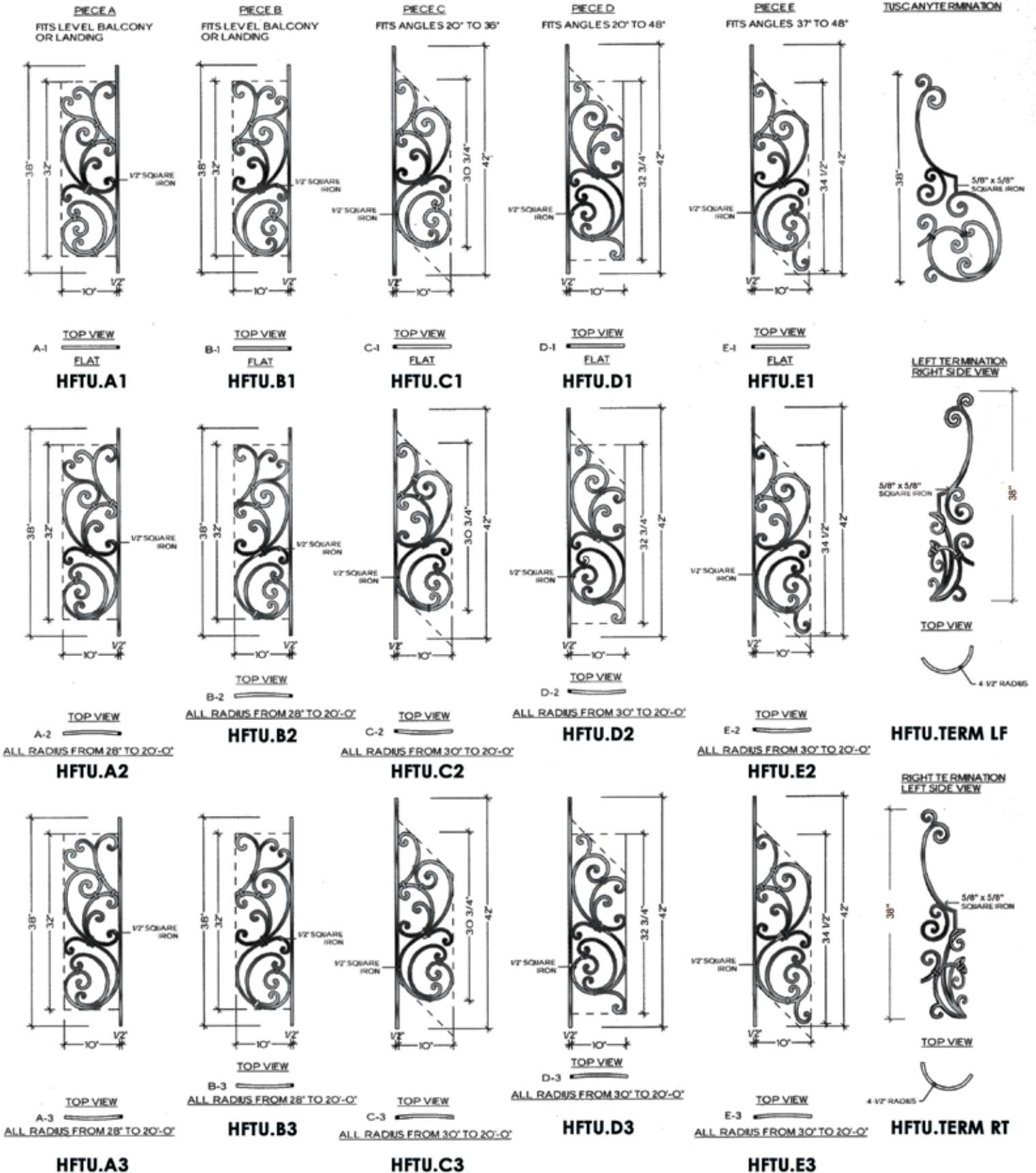



Tuscany panels paired with Gothic balusters (shown)

SEVILLE



Seville HFSE.A1 (shown)

1/2" SQUARE IRON



45° ANGLE
2-1/2" WOODEN HANDRAIL
30" BALUSTER SPACE
4" VERTICAL STRINGER

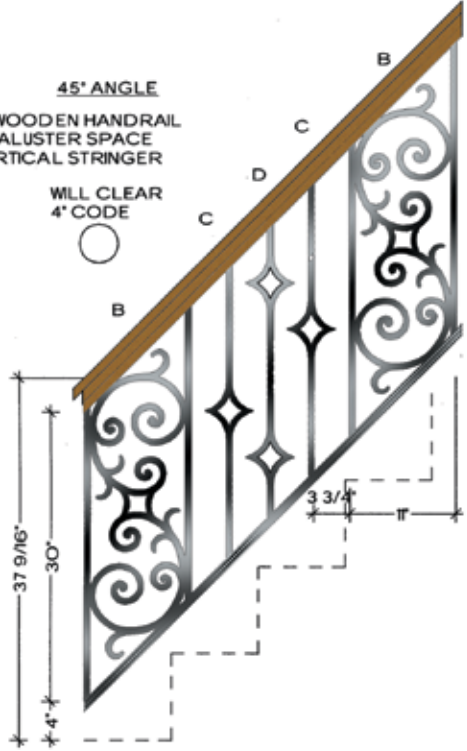

30° ANGLE
3" WOODEN HANDRAIL
30" BALUSTER SPACE
4" VERTICAL STRINGER

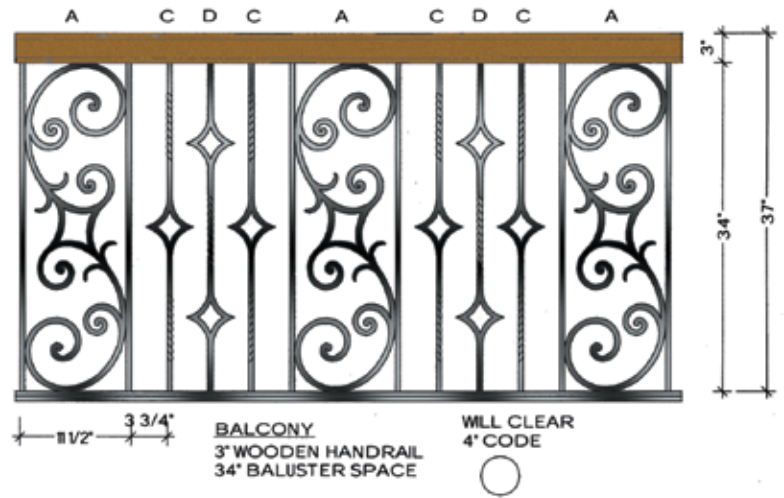
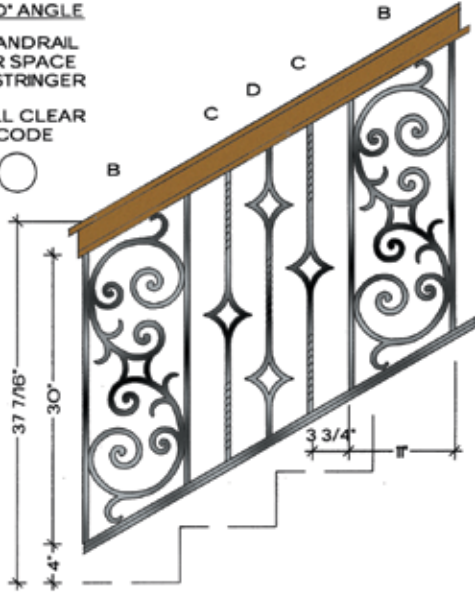

SEVILLE

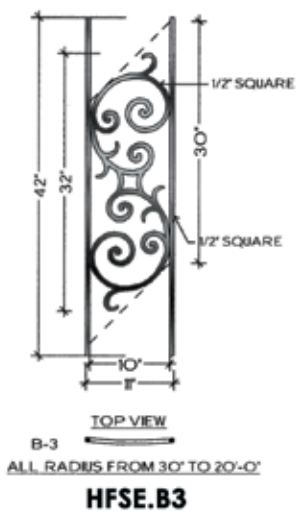
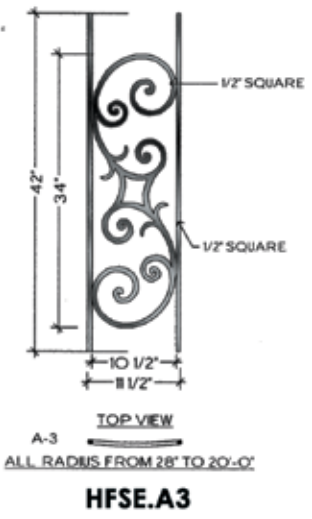
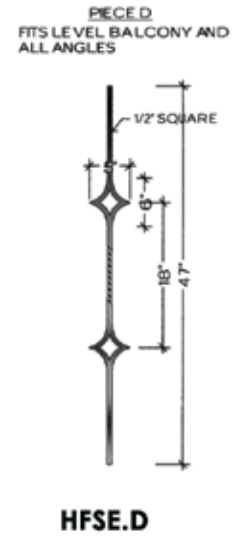
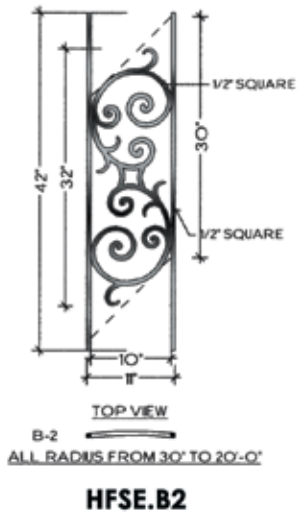
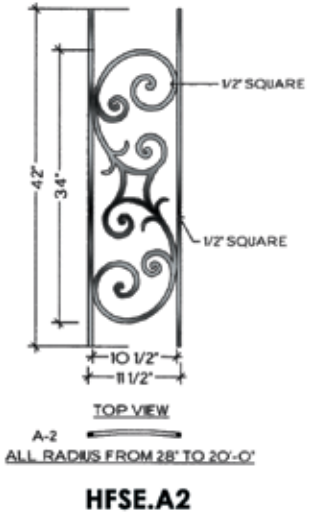
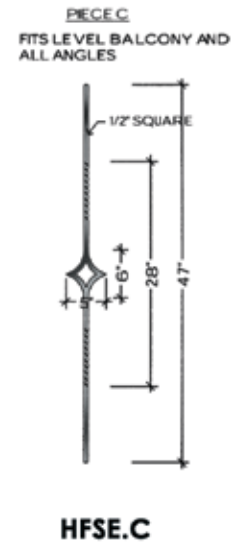
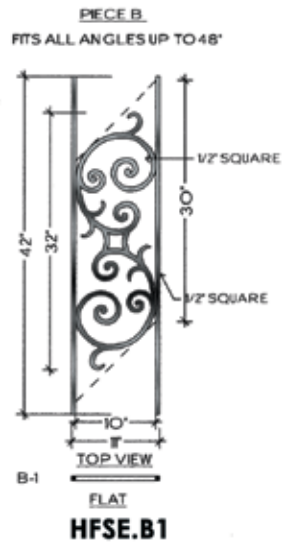
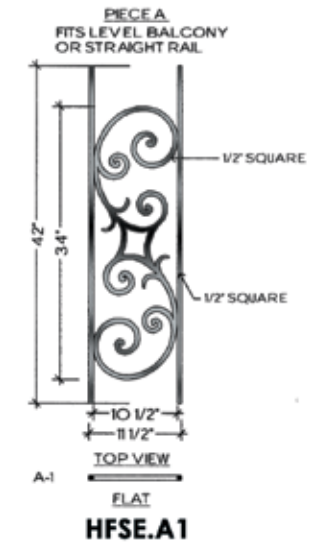

MILANO

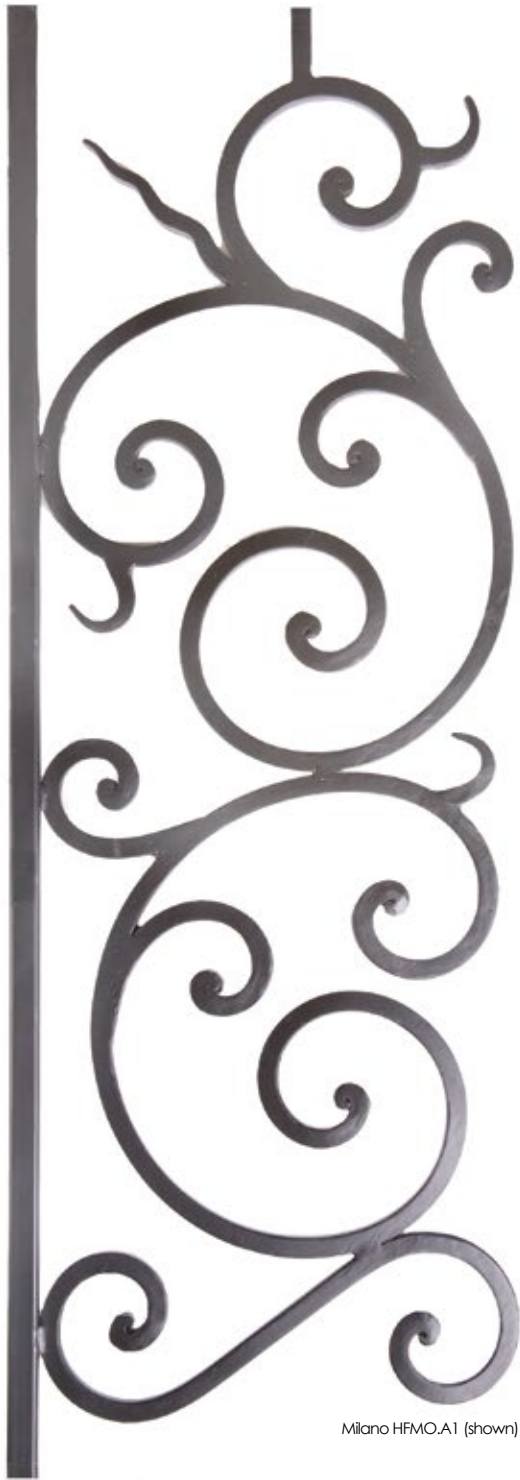

Milano HFMO.A1 (shown)

3/4" SQUARE TUBE



1/2" SQUARE IRON

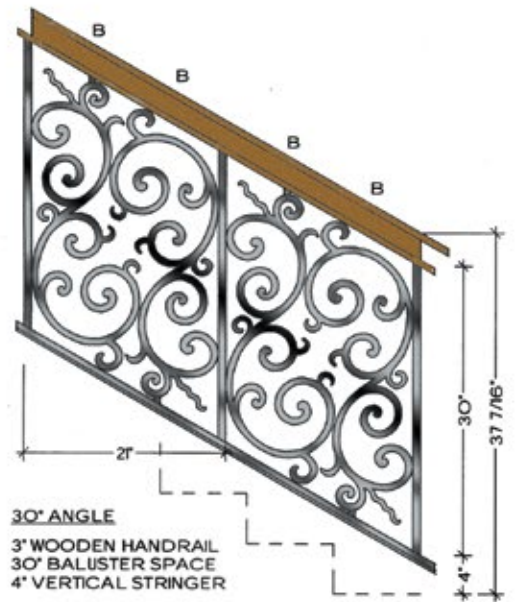

WILL CLEAR 4" CODE

"NOTE: THE MILANO LAYOUT REQUIRES THE REMOVAL OF SOME ATTACHED VERTICALS AND REWELDING SCROLLS TO PREVIOUS VERTICAL"

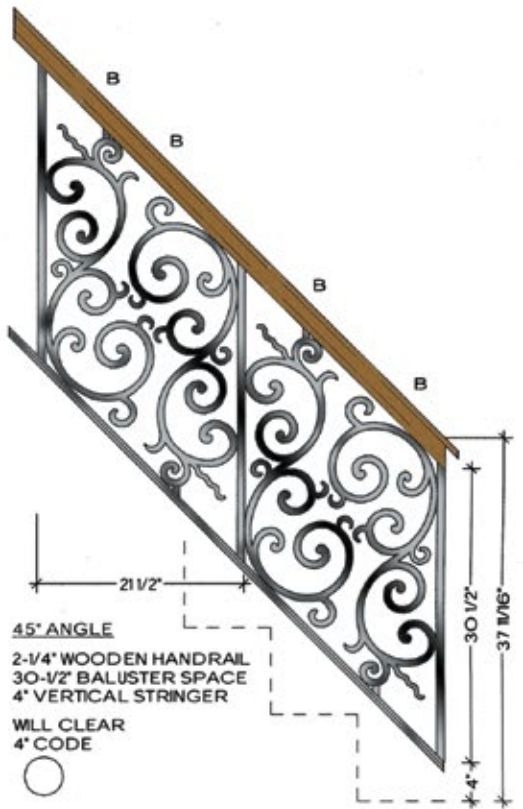

WILL CLEAR 4" CODE

MILANO

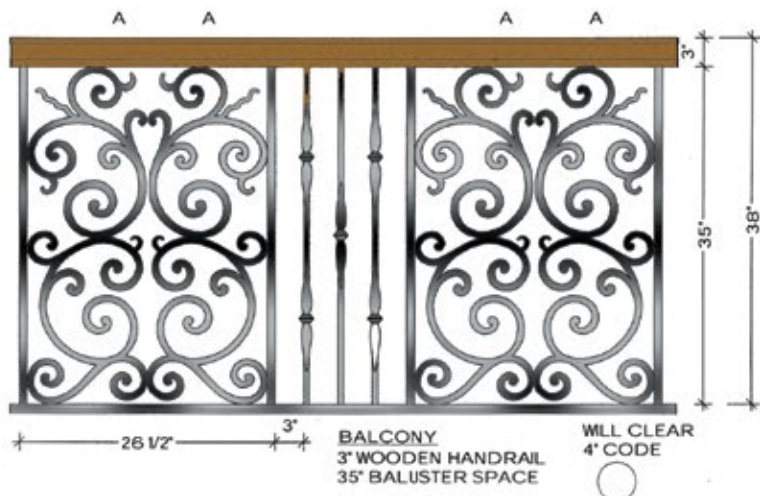
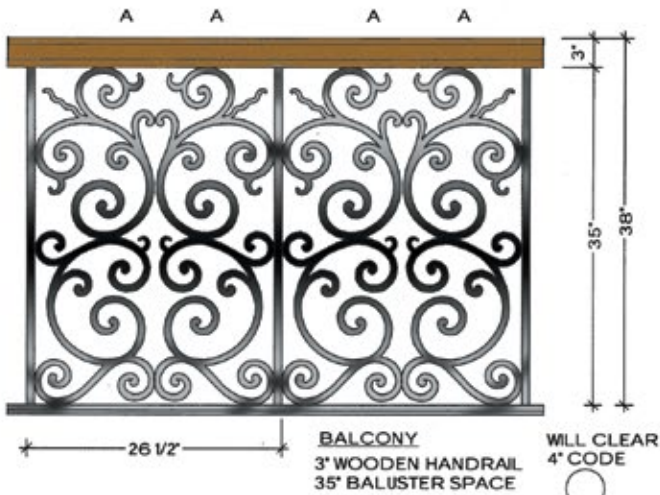
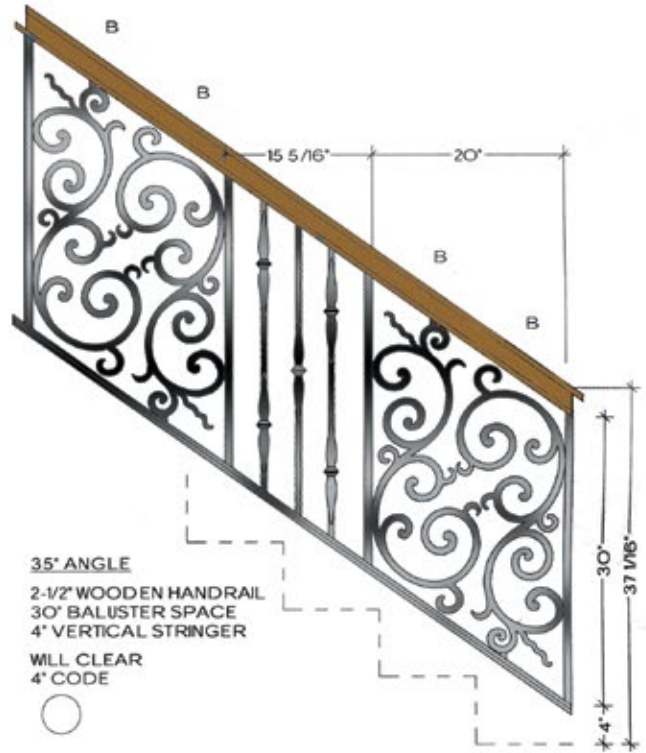
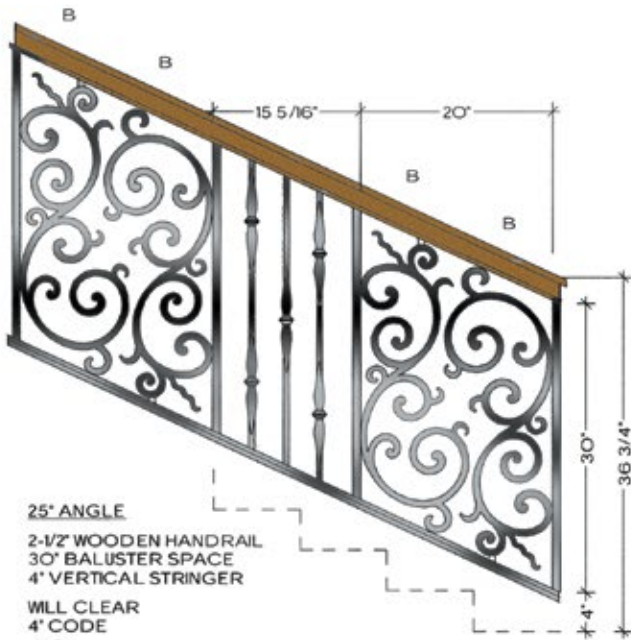

MILANO

PIECE A
FITS LEVEL BALCONY OR LANDING

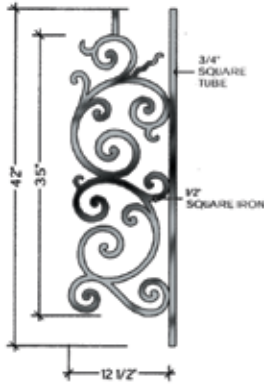

TOP VIEW
A-1
FLAT
HFM0.A1

PIECE B
FITS ALL ANGLES UP TO 48°

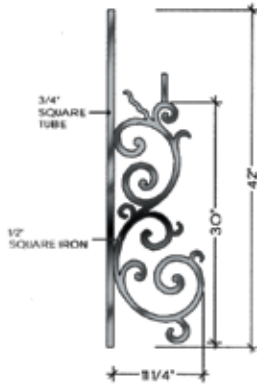

TOP VIEW
B-1
FLAT
HFM0.B1

PIECE B
FITS ALL ANGLES UP TO 48°

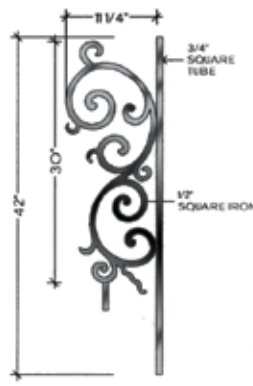

TOP VIEW
B-1
FLAT
HFM0.B1

TERMINATION

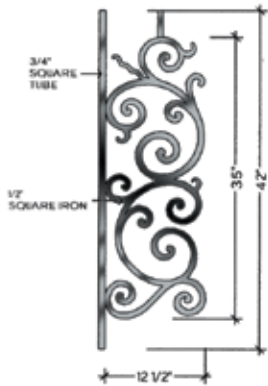
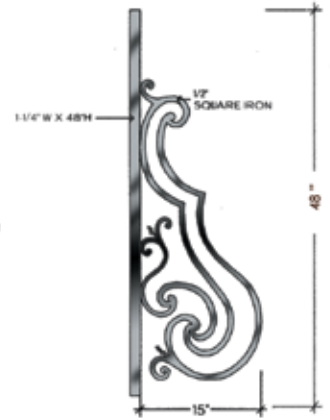

TOP VIEW
A-2
ALL RADIUS FROM 28" TO 20'-0"
HFM0.A2

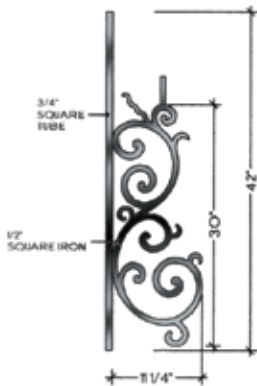

TOP VIEW
B-2
ALL RADIUS FROM 30" TO 20'-0"
HFM0.B2

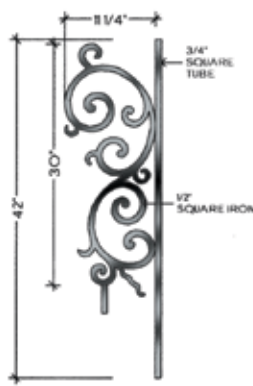

TOP VIEW
B-2
ALL RADIUS FROM 30" TO 20'-0"
HFM0.B2

LEFT TERMINATION
RIGHT SIDE VIEW



HFM0.TERM LF

RIGHT TERMINATION
LEFT SIDE VIEW

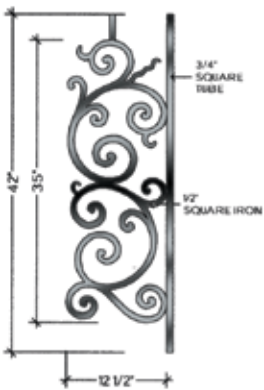

TOP VIEW
A-3
ALL RADIUS FROM 28" TO 20'-0"
HFM0.A3

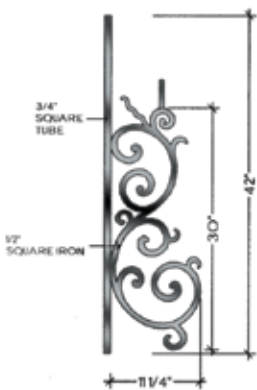

TOP VIEW
B-3
ALL RADIUS FROM 30" TO 20'-0"
HFM0.B3

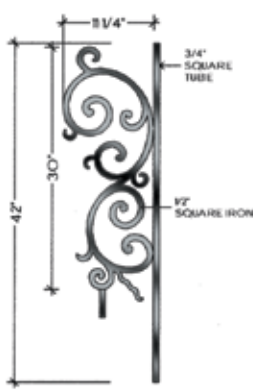

TOP VIEW
B-3
ALL RADIUS FROM 30" TO 20'-0"
HFM0.B3

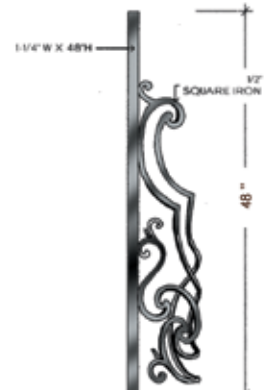

HFM0.TERM RT



BORDEAUX



Bordeaux HFBX.A1 (shown)

3/4" SQUARE
TUBE



5/8" SQUARE
IRON

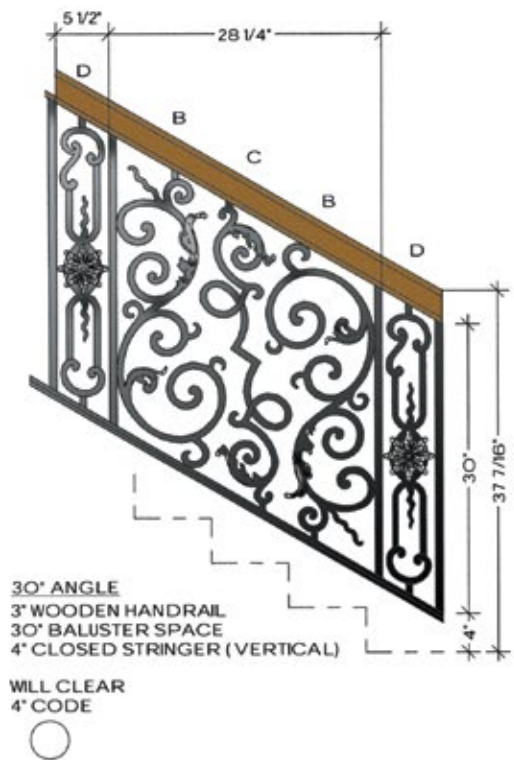
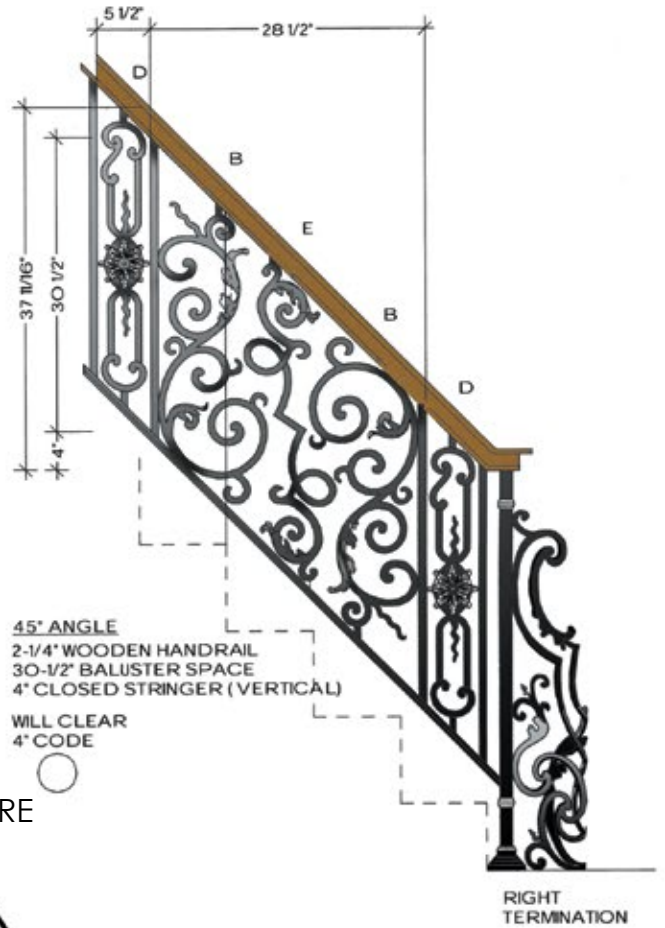

BORDEAUX

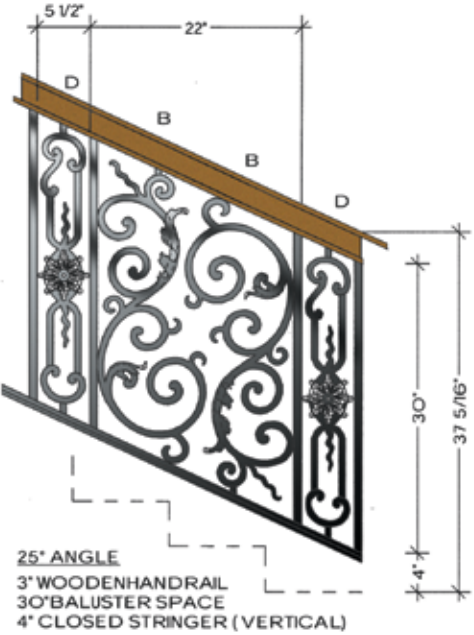

25° ANGLE
 3" WOODEN HANDRAIL
 30° BALUSTER SPACE
 4" CLOSED STRINGER (VERTICAL)

WILL CLEAR
 4" CODE

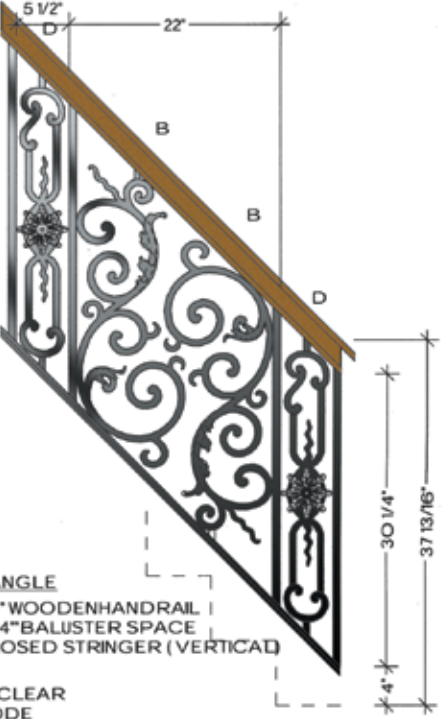

45° ANGLE
 2-3/4" WOODEN HANDRAIL
 30-1/4° BALUSTER SPACE
 4" CLOSED STRINGER (VERTICAL)

WILL CLEAR
 4" CODE

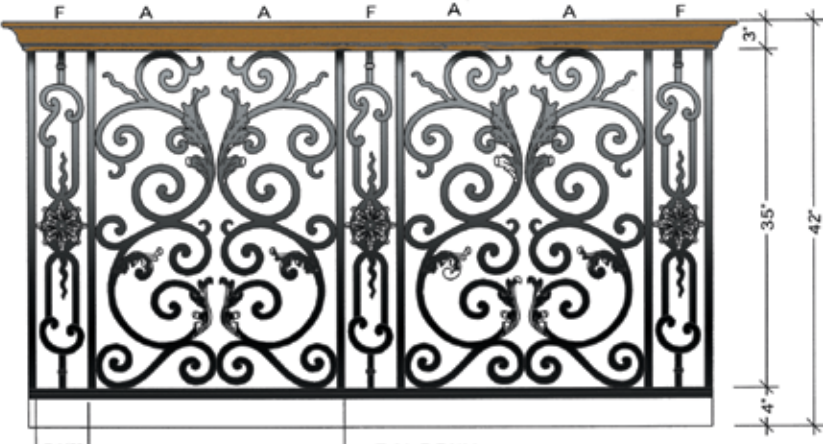

BALCONY
 3" WOODEN HANDRAIL
 35° BALUSTER SPACE
 4" CLOSED STRINGER

WILL CLEAR
 4" CODE

BORDEAUX

PIECE A
FITS LEVEL BALCONY OR STRAIGHT RAILS

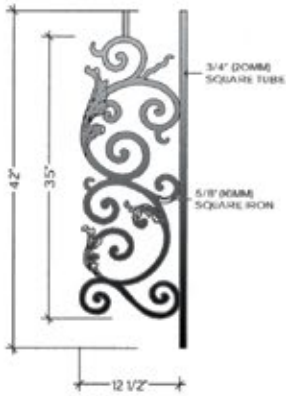

TOP VIEW
A-1
FLAT
HFBX.A1

PIECE B
FITS ALL ANGLES UP TO 4 8"

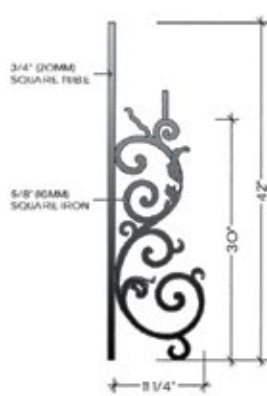

TOP VIEW
B-1
FLAT
HFBX.B1

PIECE B
FITS ALL ANGLES UP TO 4 8"

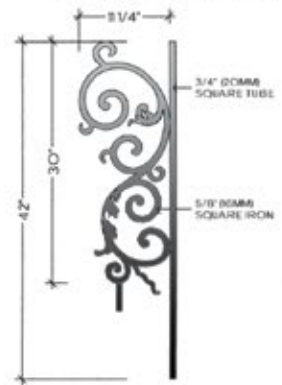

TOP VIEW
B-1
FLAT
HFBX.B1

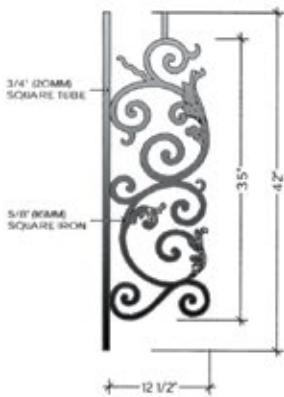

TOP VIEW
A-2
ALL RADIUS FROM 28" TO 20'-0"
HFBX.A2

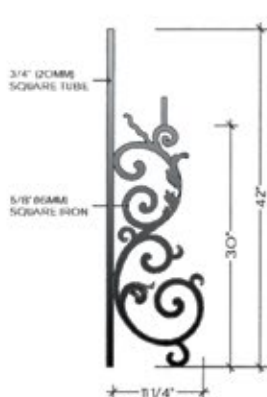

TOP VIEW
B-2
ALL RADIUS FROM 30" TO 20'-0"
HFBX.B2

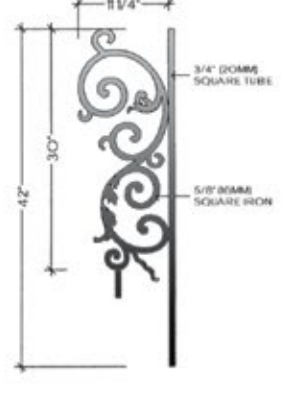

TOP VIEW
B-2
ALL RADIUS FROM 30" TO 20'-0"
HFBX.B2

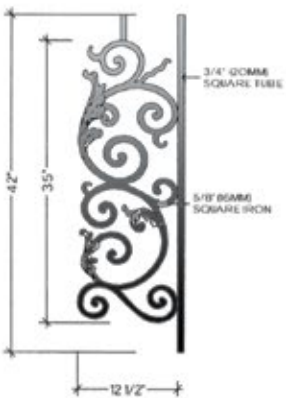

TOP VIEW
A-3
ALL RADIUS FROM 28" TO 20'-0"
HFBX.A3

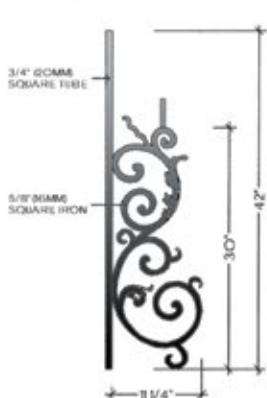

TOP VIEW
B-3
ALL RADIUS FROM 30" TO 20'-0"
HFBX.B3

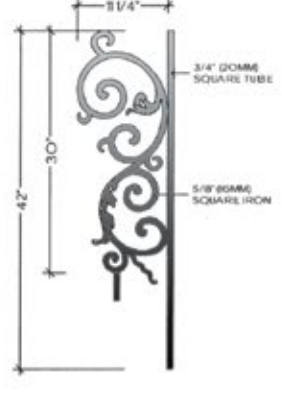

TOP VIEW
B-3
ALL RADIUS FROM 30" TO 20'-0"
HFBX.B3

BORDEAUX

PIECE C
FITS ONLY INCLINE ANGLES BELOW 40°

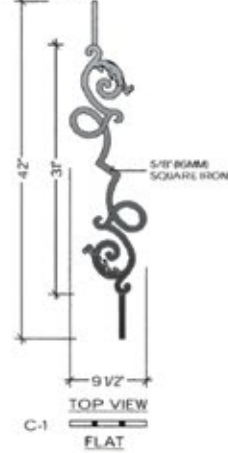

HFBX.C1

PIECE D
FITS ALL ANGLES



HFBX.D

PIECE E
FITS ONLY ANGLES ABOVE 40°

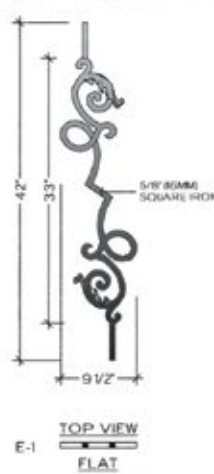

HFBX.E1

RIGHT TERMINATION
INSIDE VIEW

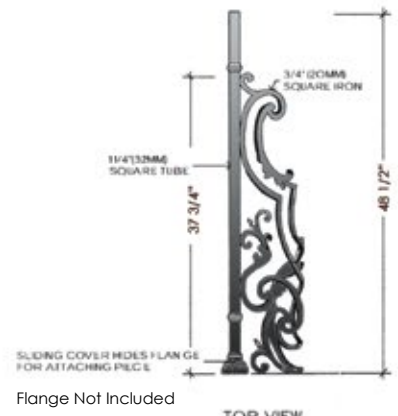

Sliding cover hides flange for attaching piece E
Flange Not Included

TOP VIEW

HFBX.TERM RT

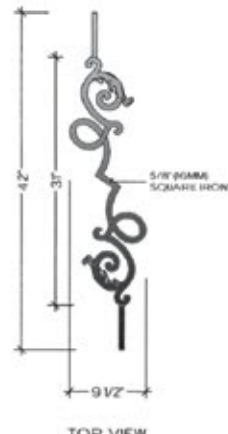

HFBX.C2

PIECE F
FITS LEVEL BALCONY OR STRAIGHT RAIL

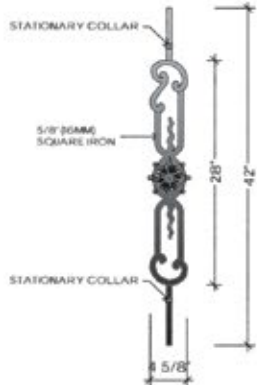

HFBX.F

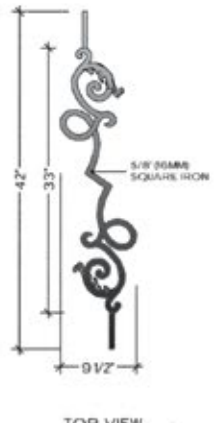

HFBX.E2

LEFT TERMINATION
INSIDE VIEW

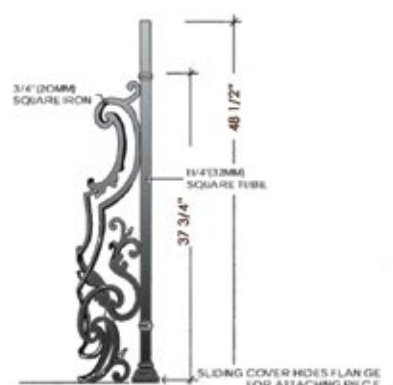

Sliding cover hides flange for attaching piece E
Flange Not Included

TOP VIEW

HFBX.TERM LF

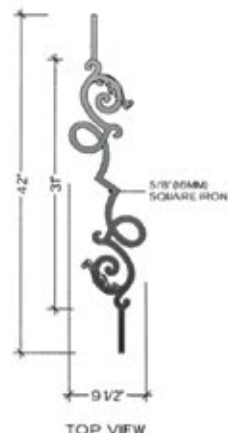

HFBX.C3

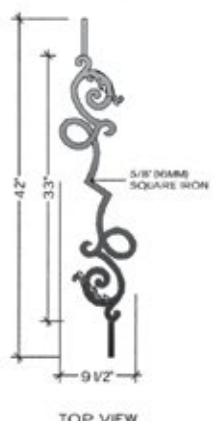

HFBX.E3

REGENCY



Regency HFREA1 (shown)

1" SQUARE
TUBE

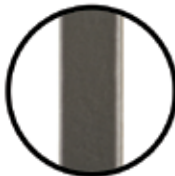

3/8" X 1"
FLAT IRON

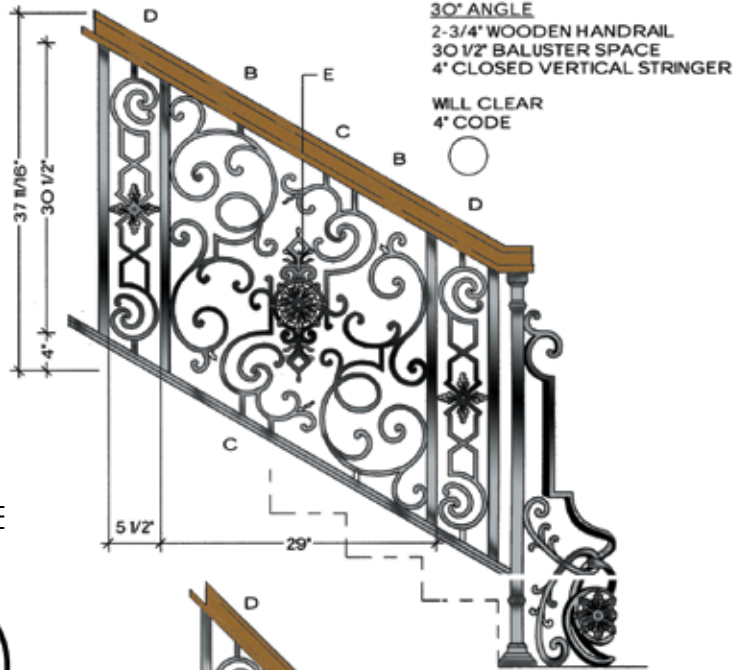

RIGHT REGENCY
TERMINATION

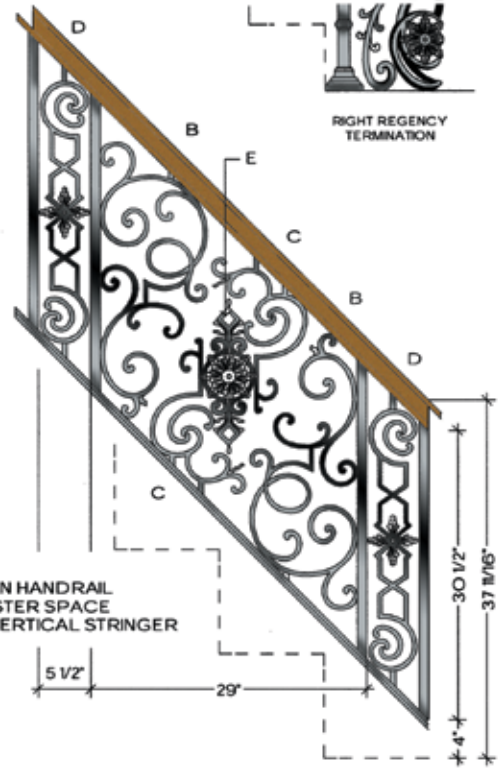

WILL CLEAR
4" CODE



BALCONY

2 3/4" WOODEN HANDRAIL
35" BALUSTER SPACE

WILL CLEAR
4" CODE

REGENCY

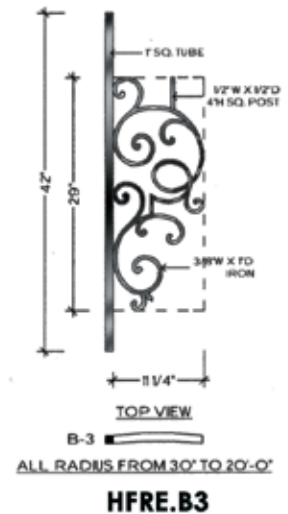
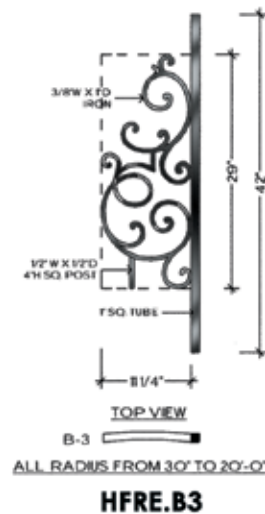
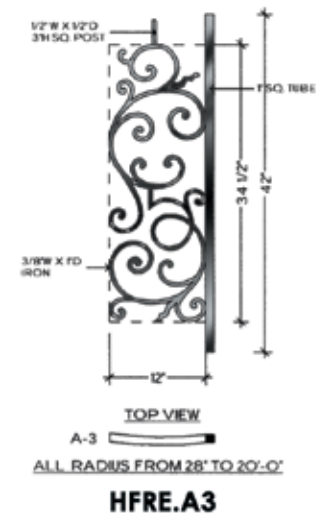
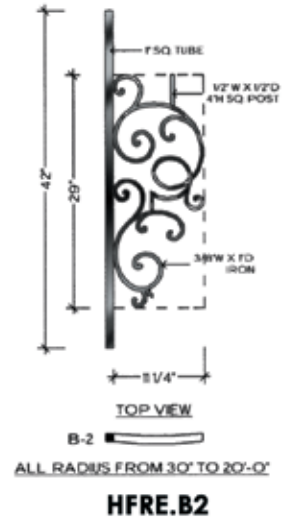
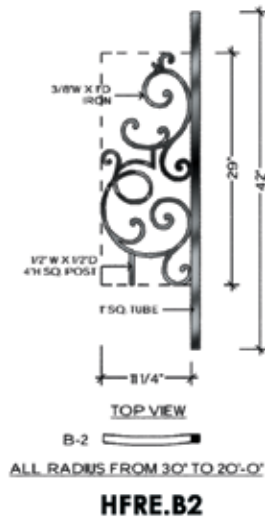
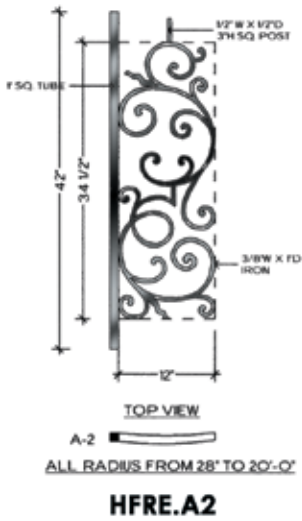
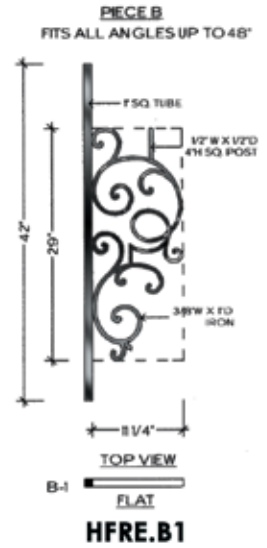
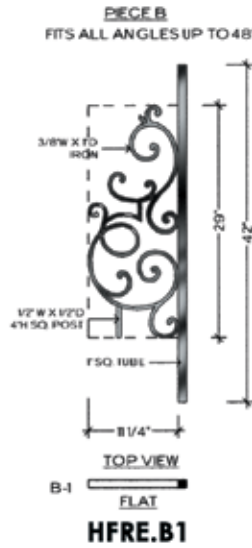
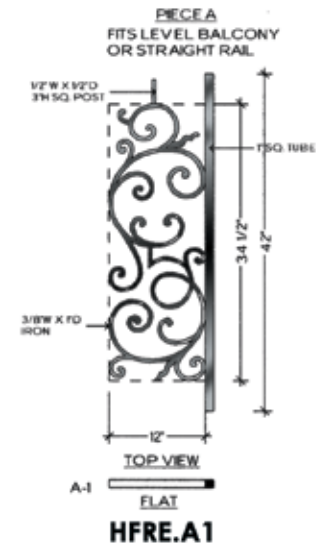

REGENCY

PIECE C
FITS ALL ANGLES UP TO 48°

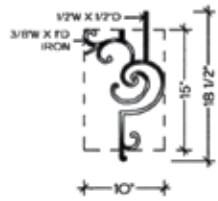

TOP VIEW
FLAT

HFRE.C1

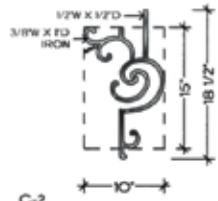

TOP VIEW
FLAT

ALL RADIUS FROM 30° TO 20°-0'

HFRE.C2

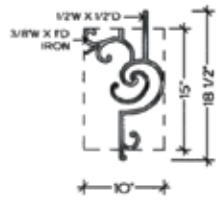

TOP VIEW
FLAT

ALL RADIUS FROM 30° TO 20°-0'

HFRE.C3

PIECE D
FITS ALL ANGLES &
LEVEL BALCONY



TOP VIEW
FLAT

HFRE.D

PIECE C
FITS ALL ANGLES UP TO 48°

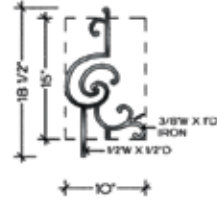

TOP VIEW
FLAT

HFRE.C1

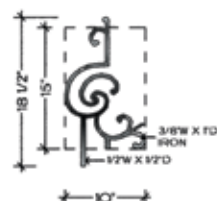

TOP VIEW
FLAT

ALL RADIUS FROM 30° TO 20°-0'

HFRE.C2

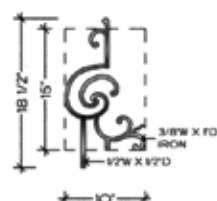

TOP VIEW
FLAT

ALL RADIUS FROM 30° TO 20°-0'

HFRE.C3

PIECE E
FITS ALL ANGLES

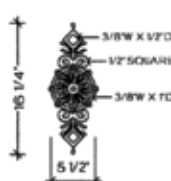

HFRE.E

LEFT SIDE TERMINATION
RIGHT SIDE VIEW

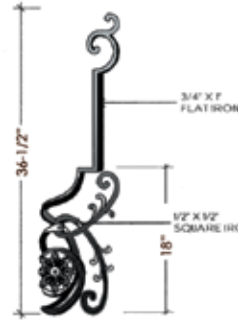

HFRE.TERM LF

RIGHT SIDE TERMINATION
LEFT SIDE VIEW

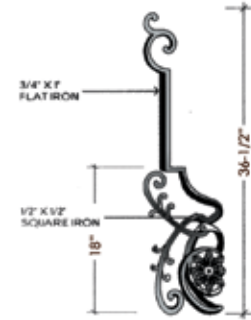

HFRE.TERM RT

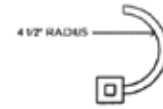

TERMINATION



PIECE F
FITS LEVEL BALCONY
OR STRAIGHT RAIL

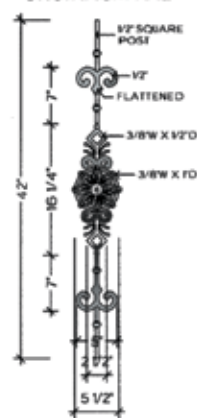

TOP VIEW
FLAT

HFRE.F



U.S. Pat.
No. 5,820,111
No. 6,059,269

Regency panels (shown)

Regency[©] 79

Wood Products

At House of Forgings we provide much more than just forged iron products, we boast an extensive line of wood components as well.

From handrails to treads, we carry virtually all components necessary to create the staircase or balcony you have envisioned. All products are stocked in Red Oak or Paint Grade, ready for immediate shipping. Components are packaged and shipped with the utmost integrity ensuring that your order will arrive on time and undamaged.

STAIR & RAILING PRODUCTS BY





Elegante-Column newels (RO-4480/RO-4485) paired with Twist/Scroll balusters (shown)

BLANKS



Prefinished white
4923-41
HT. 41"
W = 1-3/4"
4913-41
HT. 41"
W = 1-1/4"

CLASSIC



CLASSIC



5067-39
HT. 39"
W = 1-1/4"

5067-41
HT. 41"
W = 1-1/4"

* SPECIAL ORDER

* SPECIAL ORDER

All newels stocked in Red Oak (RO), all balusters stocked in prefinished white (PG)

REMINGTON



MAGNOLIA

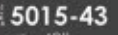
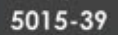
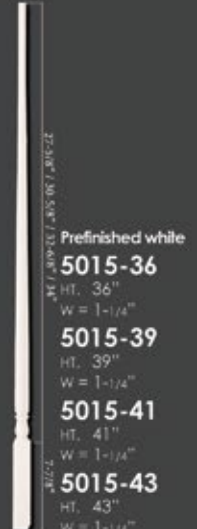
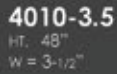

CONCORD



ELEGANTE-COLUMN



4480
HT. 56"
W = 5-1/2"



4485-5
HT. 56"
W = 3-1/4"



4485
HT. 48"
W = 3-1/4"

ELEGANTE-TWIST



4440
HT. 56"
W = 5-1/2"



4450-5
HT. 56"
W = 3-1/4"



4450
HT. 48"
W = 3-1/4"

All Elegante newels and balusters stocked in Red Oak (RO)

BOX NEWELS



Contemporary
Box Newel
4191
HT. 56"
W = 3-1/4"
SOLID



Contemporary
Stabilizer Newel
4191-SP
HT. 43"
W = 3"
SOLID



Stabilizer newels are pre drilled 1/2" x 2-1/8" (7/16" x 3" dowel included)



Plain Box
Newel
961-56
HT. 56"
W = 4-1/2"
SOLID



Recessed Panel
Box Newel
4291
HT. 56"
W = 6"
HOLLOW



All box newels come with both square and pyramid tops

BOX NEWELS



Adjustable
Box Newel
4592
HT. 56"
W = 5"
SOLID



Plain Newel
4592-PLAIN
HT. 56"
W = 3-1/2"
SOLID



Stabilizer Newel
4592-SP
HT. 43"
W = 3"
SOLID

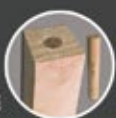

Stabilizer newels are pre drilled 1/2" x 2-1/8" (7/16" x 3" dowel included)



Raised Panel
Box Newel
4791
HT. 56"
W = 6-1/4"
HOLLOW



Fluted Box
Newel
4891
HT. 56"
W = 6-1/4"
HOLLOW



Recessed Panel
Box Newel
4991
HT. 56"
W = 6-1/4"
HOLLOW

All box newels stocked in Red Oak (RO)



RO-4691 Box Newel and 4923-41 Balusters (shown)



RO-4191 Box Newels paired with Versatile balusters (shown)



RO-4291 Box Newels paired with Versatile balusters (shown)

HANDRAIL & FITTINGS

6040



6040
Round Wall Rail
Diameter: 1-5/8"

RETURNED END



7009
7209
7709

6010



Colonial Hand Rail
HT. 2-3/8"
W. 2-1/2"

6010 Straight Rail
6010-B Bending Rail
bending rail includes moulding



OPENING CAP



7019
7219
7719

6210



Traditional Hand Rail
HT. 2-3/8"
W. 2-5/8"

6210 Straight Rail
6210-B Bending Rail
bending rail includes moulding



TANDEM CAP



7020
7220
7720

6710



Prestige Hand Rail
HT. 2-3/4"
W. 2-5/8"

6710 Straight Rail
6713 Bending Rail
bending rail includes moulding

OVER EASING



7013
7213
7713

6002

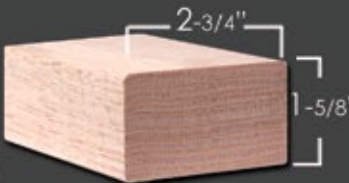

Modern Hand Rail
HT. 1-3/8"
W. 2-3/4"

6002 Straight Rail
no fittings available

UP EASING 90 DEGREE



7012 7014
7212 7214
7712 7714

6084



Modern Hand Rail
HT. 1-3/4"
W. 2-3/8"

6084 Straight Rail
no fittings available



START EASING WITH CAP



7010
7210
7710

All handrail and fittings stocked in Red Oak (RO)

LEVEL QUARTER TURN



- 7011
- 7211
- 7711

LEVEL QUARTER TURN WITH CAP



- 7021
- 7221
- 7721

LEFT & RIGHT HAND S-TURNS



- | | |
|--------|--------|
| 7022-L | 7022-R |
| 7222-L | 7222-R |

LEFT & RIGHT HAND TURNOUTS



- | | |
|-----------|------------|
| LEFT HAND | RIGHT HAND |
| 7040 | 7045 |
| 7240 | 7245 |
| 7740 | 7745 |

2 RISE STRAIGHT GOOSENECK



- 7099
- 7299
- 7799

LEFT & RIGHT HAND VOLUTES



- | | |
|-----------|------------|
| LEFT HAND | RIGHT HAND |
| 7030 | 7035 |
| 7230 | 7235 |
| 7730 | 7735 |

2 RISE STRAIGHT GOOSENECK WITH CAP



- 7088-2
- 7288-2
- 7788-2

2 RISE LEFT & RIGHT HAND GOOSENECK



- | | |
|-----------|------------|
| LEFT HAND | RIGHT HAND |
| 7071 | 7076 |
| 7271 | 7276 |
| 7771 | 7776 |

2 RISE LEFT & RIGHT HAND GOOSENECK WITH CAP



- | | |
|-----------|------------|
| LEFT HAND | RIGHT HAND |
| 7081 | 7086 |
| 7281 | 7286 |
| 7781 | 7786 |

All handrail and fillings stocked in Red Oak (RO)

TREADS/STEPS/LUMBER/PLY

TREADS

RO-8070

Red Oak Bull Nose Tread
1-1/16" x 11-1/2" x 42, 48, 54,
60, 72, 84, 96"



CLASSIC TREADS

RO-8070-13 x

Red Oak Tread
1-1/16" x 13" x 48, 60, 72, 96"

RO-8070-18 x

Red Oak Tread
1-1/16" x 18" x 48, 60, 72, 84"

RO-8070-20 x 60

Red Oak Tread
1-1/16" x 20" x 60"

RO-8070-20 x 72

Red Oak Tread
1-1/16" x 20" x 72"

RO-8070-24 x

Red Oak Tread
1-1/16" x 24" x 60", 72", 84", 96", 120"

RO-8070-48 x 48

Red Oak Tread
1-1/16" x 48" x 48"

RO-8070-60 x 60

Red Oak Tread
1-1/16" x 60" x 60"

RO-8070-48-MR

1-1/16" x 11-1/2" x 48"

RO-8070-54-MR

1-1/16" x 11-1/2" x 54"

RO-8070-60-MR

1-1/16" x 11-1/2" x 60"

Mitered Return(MR)(Reversible)

Overall length does not include mitered return



REMODEL TREAD WITH RISER

TREAD Red Oak Bull Nose Tread with Cove
1 1/16" x 10-1/2" x 42, 54, 60"

RISER Red Oak Riser
5/8" x 7-1/2" x 42, 54, 60"

RETRO-42 / RETRO-54 / RETRO-60



REMODEL RETURN TREAD WITH RISER

TREAD Red Oak Bull Nose Tread with Cove
1 1/16" x 10-1/2" x 48, 54, 60"

RISER Red Oak Riser
5/8" x 7-1/2" x 48, 54, 60"

RETRO-48MR / RETRO-54MR / RETRO-60MR



BULL NOSED LANDING TREAD

8090-6

RED OAK

8090-6B

RED OAK BENDING(26 pieces)

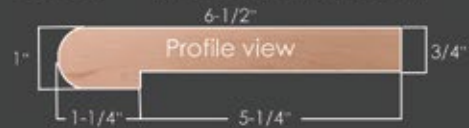

TONGUE & GROOVED BULL NOSED LANDING TREAD

8090-6-G

RED OAK(grooved)

6-1/2"



TONGUE & GROOVED LUMBER

8095-8-T&G

RED OAK (tongue & grooved)



8095-12-T&G

RED OAK (tongue & grooved)



1" BULL NOSING

8080

RED OAK

8080-B

RED OAK BENDING
(5 pieces)



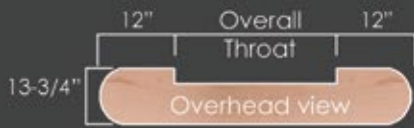

DOUBLE END STARTING STEP

Diameter: 13-3/4"
8015-48 (48" throat) (72" overall)
8015-54 (54" throat) (78" overall)
8015-60 (60" throat) (84" overall)
 Red Oak[RO]

Comes with:
 1" Thick Tread,
 6-3/4" Tall Riser
 Cove & Quarter Round Moulding

STARTER STEP VENEER

Width: 8"
 Length: 120"
RO-VENEER (Red Oak)

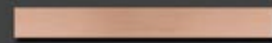

SINGLE END STARTING STEP

Diameter: 13-3/4"
8010-48 (48" throat) (60" overall)
8010-60 (60" throat) (72" overall)
8010-72 (72" throat) (84" overall)
 Red Oak[RO]

Comes with:
 1" Thick Tread,
 6-3/4" Tall Riser
 Cove & Quarter Round Moulding



SPECIAL WEDGE SHAPED DOUBLE END STARTING STEP

Diameter: 12-3/4" (small end)
 Diameter: 18-1/2" (large end)
RO-8915-48 (48" throat) (73-1/2" overall)
RO-8915-54 (54" throat) (79-1/2" overall)
 (Reversible)
 Red Oak[RO]

Comes with:
 1" Thick Tread,
 6-3/4" Tall Riser
 Cove & Quarter Round Moulding



FALSE END STARTING STEP

Diameter: 13-3/4" Diameter: 17-1/2"
 Length: 17-5/8" overall Length: 21-3/4" overall
8011 **8012**
 Red Oak[RO]

Comes with:
 1" Thick Tread,
 6-3/4" Tall Riser
 Cove & Quarter Round Moulding

PLYWOOD

PLY-1/4-MDF	MDF 1/4" x 4' x 8'	Half Sheet 1/4" x 2' x 8'
PLY-3/4-MDF	MDF 3/4" x 4' x 8'	
PLY-1/8-RO	Red Oak 1/8" x 4' x 8'	Half Sheet 1/4" x 2' x 8'
PLY-1/4-RO	Red Oak 1/4" x 4' x 8'	Half Sheet 1/4" x 2' x 8'
PLY-1/2-RO	Red Oak 1/2" x 4' x 8'	
PLY-3/4-RO	Red Oak 3/4" x 4' x 8'	
PLY-1/8-Birch	Birch 1/8" x 4' x 8'	
PLY-1/4-Birch	Birch 1/4" x 4' x 8'	Half Sheet 1/4" x 2' x 8'
PLY-1/2-Birch	Birch 1/2" x 4' x 8'	
PLY-3/4-Birch	Birch 3/4" x 4' x 8'	
PLY-3/8-Bending	Red Oak 3/8" x 4' x 8' (bending board)	

LUMBER

RO-06	Red Oak 3/4" x 5-1/2" S4S Lumber
RO-08	Red Oak 3/4" x 7-1/4" S4S Lumber
RO-08-B	Red Oak 3/4" x 7-1/4" Bending (29 pieces)
RO-12	Red Oak 3/4" x 11-1/4" S4S Lumber
MDF-06	MDF 11/16" x 5-1/4"
MDF-08	MDF 11/16" x 7-1/4"
MDF-12	MDF 11/16" x 11-1/4"

WOOD MOULDING & FLEXIBLE TRIM



RO-C8	Red Oak 2-1/2" x 11/16" Colonial Casing
PG-C8	Paint Grade 2-1/2" x 11/16" Colonial Casing
FLEX-C8	Paint Grade 2-1/2" x 11/16" Colonial Casing



PG-CAP MOULD	Paint Grade 1-1/8" x 3/8" Cap Mould
---------------------	-------------------------------------

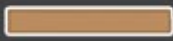

RO-6007	Red Oak 1-3/4" Filet
PG-6007	Paint Grade 1-3/4" Filet



RO-6050	Red Oak 1-1/4" Filet
PG-6050	Paint Grade 1-1/4" Filet



RO-PM-1	Red Oak 11/16" x 1/-1/4" RAB. Panel Mould
PG-PM-1	Paint Grade 11/16" x 1/-1/4" RAB. Panel Mould
Flex-PM-1	Flexible Smooth 11/16" x 1/-1/4" RAB. Panel Mould
Flex-PM-1-WG	Flexible Wood Grain 11/16" x 1/-1/4" RAB. Panel Mould (1/4" Offset)



RO-PM-2	Red Oak 11/16" x 1/-1/4" RAB. Panel Mould
PG-PM-2	Paint Grade 11/16" x 1/-1/4" RAB. Panel Mould
Flex-PM-2	Flexible Smooth 11/16" x 1/-1/4" RAB. Panel Mould
Flex-PM-2-WG	Flexible Wood Grain 11/16" x 1/-1/4" RAB. Panel Mould (3/4" Offset)



RO-PM-5	Red Oak 11/16" x 1-1/8" Flat Panel Mould
PG-PM-5	Paint Grade 11/16" x 1-1/8" Flat Panel Mould
Flex-PM-5	Flexible Smooth 11/16" x 1-1/8" Flat Panel Mould
Flex-PM-5-WG	Flexible Wood Grain 11/16" x 1-1/8" Flat Panel Mould



RO-8050	Red Oak 7/16" x 3/4" Base Shoe Mould
Flex-MS-127	Flexible Smooth 7/16" x 3/4" Base Shoe Mould
Flex-MS-127-WG	Flexible Wood Grain 7/16" x 3/4" Base Shoe Mould



RO-8060	Red Oak 3/4" x 3/4" Cove Mould
PG-8060	Paint Grade 3/4" x 3/4" Cove Mould
Flex-MS-92	Flexible Smooth 3/4" x 3/4" Cove Mould
Flex-MS-92-WG	Flexible Wood Grain 3/4" x 3/4" Cove Mould



RO-8065	Red Oak 1/2" x 1/2" Cove Mould
PG-8065	Paint Grade 1/2" x 1/2" Cove Mould
Flex-MS-101	Flexible Smooth 1/2" x 1/2" Cove Mould
Flex-MS-101-WG	Flexible Wood Grain 1/2" x 1/2" Cove Mould



Flex-LS-105	Flexible Smooth 3/4" x 3/4" Quarter Round Mould
Flex-LS-105-WG	Flexible Wood Grain 3/4" x 3/4" Quarter Round Mould

ACCESSORIES

WALL RAIL BRACKET

1-1/4" x 2-3/8" Mounting Plate
3" Extension From Wall



- HFBC.3002 (BRUSHED CHROME)
- HFCV.3002 (COPPER VEIN)
- HFORB.3002 (OIL RUBBED BRONZE)
- HFORC.3002 (OIL RUBBED COPPER)
- HFPB.3002 (POLISHED BRASS)
- HFSC.3002 (SATIN CLEAR)
- HFSP.3002 (SILVER VEIN)
- HFSTB.3002 (SATIN BLACK)
- HFAG.3002 (ASH GREY)

HANDRAIL BRACKET

2-1/16" Rd. Mounting Plate
3" Extension From Wall



- HFBC.3003 (BRUSHED CHROME)
- HFAN.3003 (ANTIQUE NICKEL)
- HFCE.3003 (CHROME)
- HFNL.3003 (NICKEL)
- HFCV.3003 (COPPER VEIN)
- HFORB.3003 (OIL RUBBED BRONZE)
- HFORC.3003 (OIL RUBBED COPPER)
- HFSC.3003 (SATIN CLEAR)
- HFSP.3003 (SILVER VEIN)
- HFSTB.3003 (SATIN BLACK)
- HFVB.3003 (VINTAGE BRASS)
- HFAG.3003 (ASH GREY)

WOOD GLUE & FILLER



S-9202 (1 Gal.)
S-9203 (32 oz.)
S-9204 (16 oz.)
S-9205 (8 oz.)
S-9200
FAM-O-WOOD
RO-9208 (Red Oak)

EPOXY GUN-EPC-112



EPOXY-EPC-410



EPOXY PASTE EPC-7



OAK ROSETTES



RO-7033 4"x 5-1/2" (Red Oak)
RO-7037 4"x 5-1/2" (Red Oak)
RO-7039 4"x 4" (Red Oak)

OAK PLUGS



RO-9001 (3/8")
RO-9002 (1/2")
RO-9003 (5/8")
RO-9004 (3/4")
RO-9005 (1")
RO-9006 (1-1/4")
RO-9007 (1-1/2")

NEWEL FASTENER

S-9403



Sure Tile

NEWEL FASTENER

S-9401

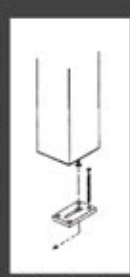

Key Lock

NEWEL CAP

SQUARE CAP-4000

3-1/4" Square
3/4" x 1" dowel



RAIL BOLT KIT

S-9600

(Includes hex nut, spacer and 1" Red Oak plug)



RAIL BOLT DRIVER

S-9600-D

(fits machine thread)



sold individually

DOWEL SCREW

C-905-2 (25 per bag)



DRIVER

C-905-2D

(fits wood screw thread)



sold individually



Maple



Poplar



White Oak



Red Oak (RO)



Prefinished White (PG)



Hickory/Pecan



Clear Alder



American Cherry



Walnut



Sapele Mahogany



Brazilian Cherry

Wood Products

All wood products are stocked in Red Oak(RO) or Prefinished White(PG) unless otherwise noted.

Domestic and Exotic Wood Species

All wood products in non-stock species are available by special order.



Custom Fabrication & Powdercoating

We specialize in modifying our standard iron components to suit the needs of your specific project. Whether your project involves balusters to be extended, panels modified to ensure code compliance or matching one of our powdercoated finishes or patinas we can help.



Marketing Literature

We offer a wide array of marketing literature designed to support product sales: product catalogs, brochures, flyers, postcards and customized literature are available through our authorized dealer program.



Sales Displays & Product Samples

Our wide variety of sales displays will provide you with the tools to sell products. We have sizes to fit your floor space. Custom displays are also available.



Software & Design

Stair Artist stair design tool makes it easy to plan your staircase project. Our extensive library of CAD images and product photos will aid and inspire you in designing your staircase.

16684 Air Center Blvd.
Houston, Texas 77032
Toll Free 866.443.4848 Fax 281.443.1133
www.houseofforgings.net

Please contact us for more detailed information
or for a listing of distributors near you.

